

NBRI

CI/SfB		BG
(56.7)	(V4)	6
UDC		1976
	697.75	

INTRODUCTORY GUIDE TO SOLAR ENERGY

AND SOLAR WATER HEATERS

Text by
W. N. CAWOOD
and
P. A. BILLINGHAM
Revised Edition

ook verkrygbaar in Afrikaans

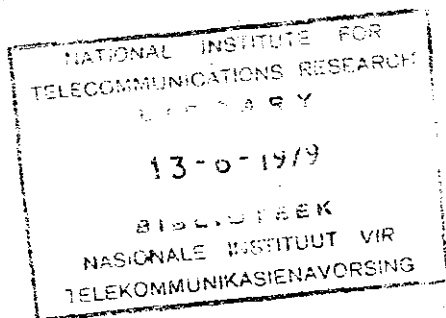

© 1977 NATIONAL BUILDING RESEARCH INSTITUTE
of the CSIR P.O. BOX 395 PRETORIA 0001

ISBN 0 7988 0834 9

Printed in South Africa
by Hortors Printers

Contents

Part I – The ideas behind the use of solar energy

Introduction 3

How much power is available to the average household? 3

Making use of solar energy 4

Solar water heaters 7

Part II – Practical solar water heaters

What is involved 11

The absorber 16

The hot water storage tank 23

The pipework 25

Forced circulation 27

Maintenance 27

Part III – Making a solar water heater

Step-by-step picture guide 30

Schematic layout of pipe connections to absorber panels 38

Check-list of components 39

Part I – The ideas behind the use of solar energy

Introduction

Since primitive man first set fire to a heap of twigs to warm his cave, mankind has been making use of the earth's energy resources. After the industrial revolution we took to burning coal and oil until today the world uses 216×10^9 GJ (60×10^{12} kWh) of energy a year.

When one tries to add up the total amount of power used by mankind since the dawn of time one arrives at the colossal figure of 2×10^{15} kWh.

It is a sobering fact that more than this amount of power in the form of solar energy falls on the earth every day and has done so for thousands of millions of years. Those precious reserves of fossil fuel which we are burning so rapidly are merely a minute fraction of the sun's energy preserved almost by chance in the distant past.

If we were to represent the time that our coal deposits have taken to form by a 24 hour clock then man will have been on earth for about six minutes; and he will probably burn up all the fossil fuel in less than a second.

Quite obviously, coal and oil represent such short-lived resources that mankind not only cannot afford to count on them for much longer, but must conserve them as far as possible.

Many of the buildings going up today could still be standing after all the available oil on earth has been used up, and this fact alone points up the futility of designing buildings that rely for their comfort on fossil fuels.

Fortunately, we still have the sun, which offers us an inexhaustible source of non-polluting energy. The earth's inhabitants will turn increasingly to it for the power they require and countries like South Africa, in parts of which the sun shines nine days out of ten, will find themselves among the energy-rich nations of the world.

How much power is available to the average household?

Measurements made by astronauts have shown that about $1\frac{1}{3}$ kilowatts of energy fall on every square metre of the earth's atmosphere. Not all of this is available at the earth's surface, because about 30 per cent is reflected back into space, but about one kilowatt per square metre is available for use.

In South Africa most places receive more than eight hours of sunshine every day, which means that a house fitted with a 50-square-metre collector on the roof could receive 100 000 kilowatt hours of energy a year.

If this could be converted into electricity, even at only 10 per cent efficiency, there would be more than enough power to provide for an average home's needs.

At present, conversion of the sun's energy to useful power is a little clumsy but it is improving all the time and there are already several ways in which the man in the street can cut himself a slice of the sunshine cake.

Making use of solar energy

Those who have followed the development of satellites will know that they draw their electrical power from the sun by means of solar cells. These consist of a semiconductor which generates an electric current when sunlight falls on it. Both current and voltage are small but when thousands of these cells are coupled together useful amounts of electric power can be obtained.

As yet, such batteries are far too expensive for normal use, but it would seem to be only a matter of time before economical devices are developed.

Meanwhile, small groups of solar cells can be used to power a small water pump. Another use is to turn a directional reflector so that it always faces the sun and so automatically collects the maximum amount of solar energy.

It is one thing for environmentalists to advocate a dramatic change over to solar energy but quite another to implement this, as it would obviously be unthinkable to scrap all fossil fuel technology unless a global catastrophe were imminent.

From what was said earlier it is obvious that the sun must eventually supply most of the earth's energy needs. In several parts of the world hot air engines that take their heat from the sun are in use to drive water pumps. One of these is powerful enough to produce 25 kilowatts of useful energy. However, efficiencies are only of the order of one per cent, which means that the collectors have to be very large. There is no doubt, though, that the efficiency of motors that run on free solar fuel will soon be improved.

In the meantime the householder can do a lot to improve his standard of comfort by making use of the solar technology that is already available. To understand how this can be done, it is

necessary to know more about how matter gains and loses energy. When we wrote about the vast quantities of energy falling on the earth, you may have asked yourself why the earth has not become impossibly hot after millions of years of cooking under a blazing sun? The answer is that the earth remains at a temperature at which the loss of heat just equals the amount it gains. In fact virtually all those vast quantities of energy are continually being lost into space by re-radiation, mostly from the night side of the earth.

There is a theory that the carbon dioxide produced by burning fossil fuels will eventually raise the temperature of the earth. The idea is that this gas will interfere with the radiation of heat into the night sky and that the temperature of the earth would then have to increase by about 2°C before the radiation would again balance the input.

The reason why some people are afraid of such an increase is that it may reduce the size of the polar ice-caps causing a decrease in the amount of solar energy reflected. With less heat being reflected by the surface the temperature of the earth would climb even higher and still more ice would melt. Sea level might eventually rise many metres, flooding most of the world's major ports.

There are as yet no grounds for believing these fears to be justified because scientists have not proved that the burning of fossil fuels increases the percentage of carbon dioxide in the atmosphere. However, the principle is sound – if one increases the insulation then the temperature will rise until the radiation rate again equals the energy input.

Applied to the world as a whole the results might be catastrophic but there are advantages in applying this principle to buildings. Catch the same amount of solar energy but make it harder for it to escape and you will have a warmer house. The opposite is also true. By shading a house to reduce the input and making it easier for the heat to escape, we make it cooler.

It is possible to build in such a way that homes will stay warmer in winter and cooler in summer and the techniques are described in another booklet in this series.*

Such systems, in which the design of a building achieves a better environment without any other aids are known as 'passive systems'.

Far more sophisticated are the 'active systems' where heat can be trapped, stored and liberated at will.

*NBRI Introductory Guide to Temperature Control
(Write to the Director, NBRI, P.O. Box 395, Pretoria, 0001.)

A good example of a kind of house incorporating both systems is one built in New Mexico to suit a climate which is considerably more extreme than that found on the highveld. (See illustration, which applies to the northern hemisphere.)

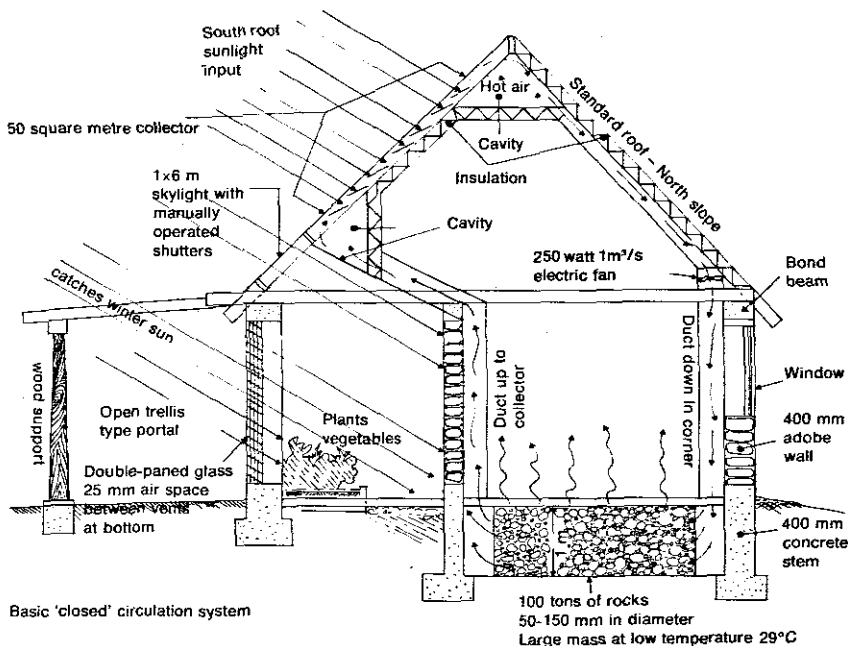

Instead of simply filling the sub-floor level of this home with soil and rubble it was filled with about a hundred tons of well-graded clean rock to act as a thermal storage area. The collector is part of the roof structure and serves to heat air which is then circulated through the sub-floor rock chamber.

In winter a fan circulates the air by day, heating the rocks below the floor and these then keep the house warm at night. In summer, cold air is circulated at night to cool the rock-bed and floor slab which in turn keep the house cool by day.

On winter mornings the house can be warmed quickly by blowing hot air from the collector directly into the rooms.

Solar water heaters have also been installed on the roof to provide a generous supply of hot water.

In Australia more than 70 schools have their indoor environment controlled by a twin rock-bed system. Air is drawn alternately in through one bed and out via the other. In winter the heat from the rooms is transferred to the outflow rock-bed and returns to the schoolrooms when the incoming airflow is switched to this rock-bed. In summer a fine water spray on to the outflow rock-bed cools it by the evaporative effect so that as soon as the airflow is switched, the cooling effect is transferred to the incoming air.

The cooling that accompanies the forced evaporation of water is the principle behind a 'natural' type of air-conditioner which is widely used in the hot dry parts of South Africa. A fan blows air through a porous medium that is kept moist by dripping water. The air takes up the water vapour and is cooled by it in the process. This way both temperature and humidity are improved at the same time. In New Mexico many houses are cooled in this way and the principle could certainly be used more widely in South Africa.

There are, of course, other active systems, some of which use water as the storage medium. An example is the house illustrated overleaf which has been built at Aachen in Germany.

Water has a particular advantage in that it takes a lot of heat to raise its temperature by a small amount. This property is made use of in the Hay house, several of which are being built in the United States. The flat roofs of these houses are covered with water-filled plastic containers which on winter days are allowed to absorb solar energy. At night they are covered with an insulating layer to prevent heat loss. During the summer, the day and night cycles are reversed to achieve maximum cooling. Water leakage can however create problems.

A house which is heated with warm air therefore has a headstart on its rivals not only because leaks do not matter but because the air cannot freeze or cause corrosion and the components usually cost less. After all, warm air is the end product in all central heating systems.

Warm water, however, is also an 'end product' that is in demand in most houses and because it is such a simple process to heat water with solar energy we will cover this subject in some detail.

Solar water heaters

There are several ways in which water can be warmed in the sun, and these can be conveniently divided into 'open' and 'closed' systems.

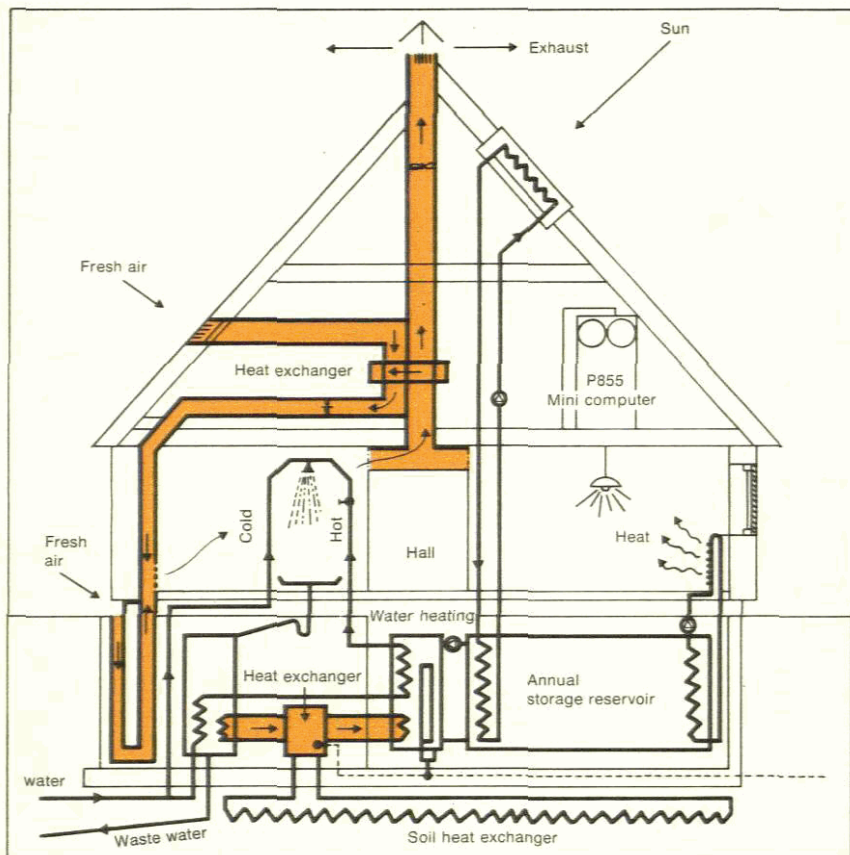

In some parts of the world the regular evening bath is prepared simply by leaving the water container standing all day in the sun. However, this very primitive open system is not very efficient because heat losses, by evaporation for example, cool the water.

Open-system water-heaters are mainly used on farms and for warming swimming pools. The water is pumped to the top of a sloping black-painted steel roof and allowed to trickle down over the hot metal. By the time the water reaches the guttering below it will have absorbed some of the heat.

Such a system can be made more efficient by covering the roof with glass to reduce evaporation but by this very step we are moving towards a closed system. The simplest of these employ a plain black-painted surface to absorb heat and it is into this group that the heaters to be described in this booklet fall.

The most basic water heater, which is ideal for a shower in an isolated building, consists merely of a 50-litre flat metal tank with one black-painted face exposed to the sun under glass and the other five faces insulated and enclosed. The tank acts both as heat absorber and storage unit and the hot water is drawn simply by displacing it with cold.

This unit is unable to store hot water overnight because of radiation losses to the night sky but an improved model is now being tested.

In more sophisticated versions a separate lagged tank is usually used to store the hot water and though this introduces some additional problems, it provides the best solution for a normal household at present. (See illustration overleaf.)

Considerable work is being done overseas on even more sophisticated collectors using either evacuated tubes or lenses which focus the sun's rays on to a black-painted copper pipe. Very high temperatures can be achieved in this way though it is usually necessary for these 'concentrating collector units' to be turned mechanically to face the sun.

Complex spiral reflectors have been devised that lead the sun's rays to the pipe regardless of the angle at which they strike the reflector, but these are expensive and also still in the experimental stage.

Whatever system is adopted, it is worth remembering that the storage tank and distribution network are basic to any hot water

Upper left: Aachen house (see page 7).

Lower left: An inexpensive type of solar water heater being installed. The tank acts as reservoir and absorber.

system and that if better and more efficient collectors come on to the market in the future it will only be necessary to add them to an existing network to obtain more or hotter hot water.

For this reason you need not feel that you are committing yourself to some system that may soon become out of date. All you are pledging yourself to do is to save money and energy now and even more money later on.

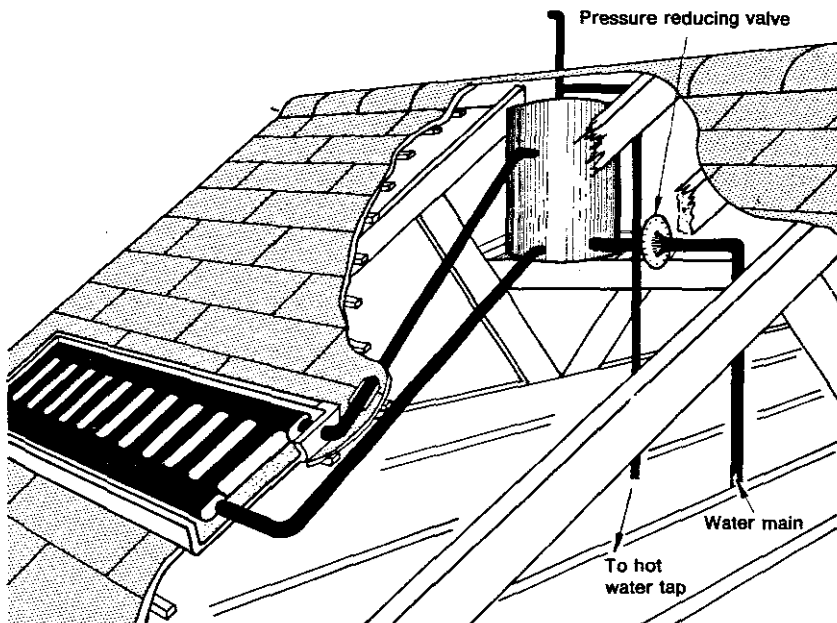

Cutaway diagram showing the layout of a solar-heated water system using an absorber panel and separate reservoir.

Part II – Practical solar water heaters

What is involved

Clearly it would be pleasant to have 'free' hot water in the house, but before making up your mind you will want to know a lot more about what is involved, and seek answers to questions such as these: Will it be unsightly? How much roof area must be given up for how much hot water? How expensive will it be? Are there any firms that will install a solar heater? How much will it cost to maintain?

A practical solar water heater may consist of an ordinary commercial radiator panel mounted on the roof and connected by insulated pipes to a hot water storage tank.

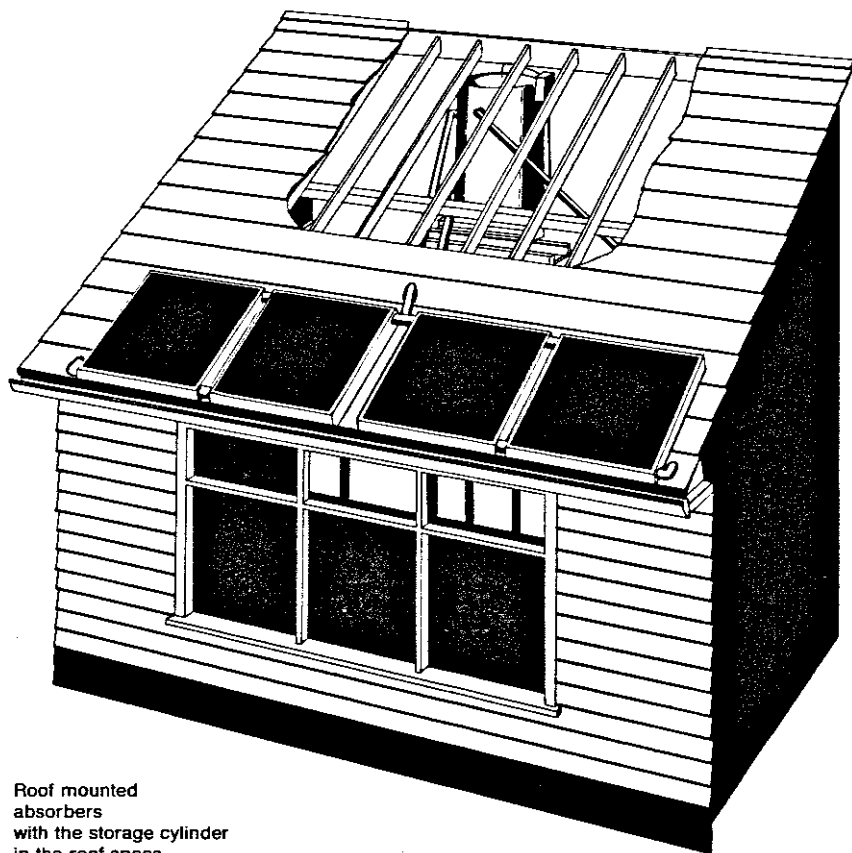

Roof mounted
absorbers
with the storage cylinder
in the roof space

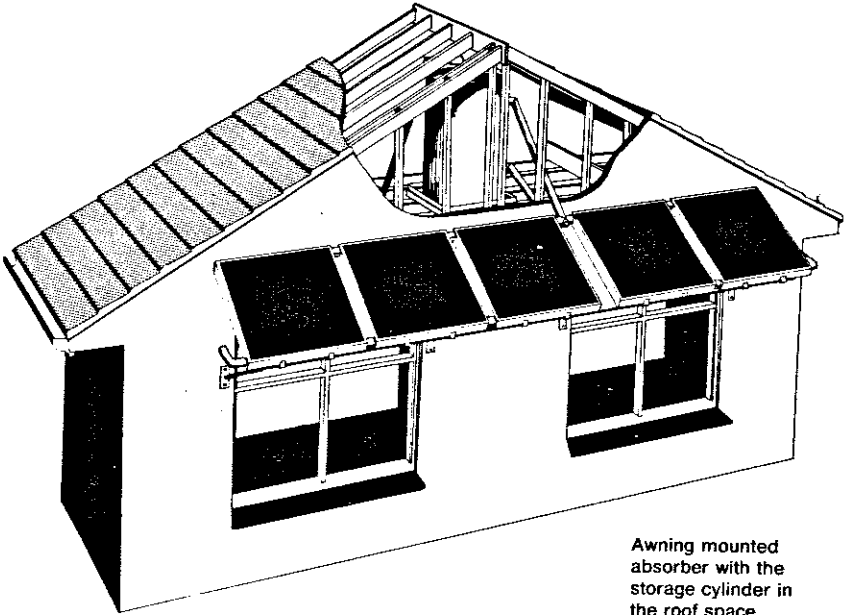

Awning mounted absorber with the storage cylinder in the roof space

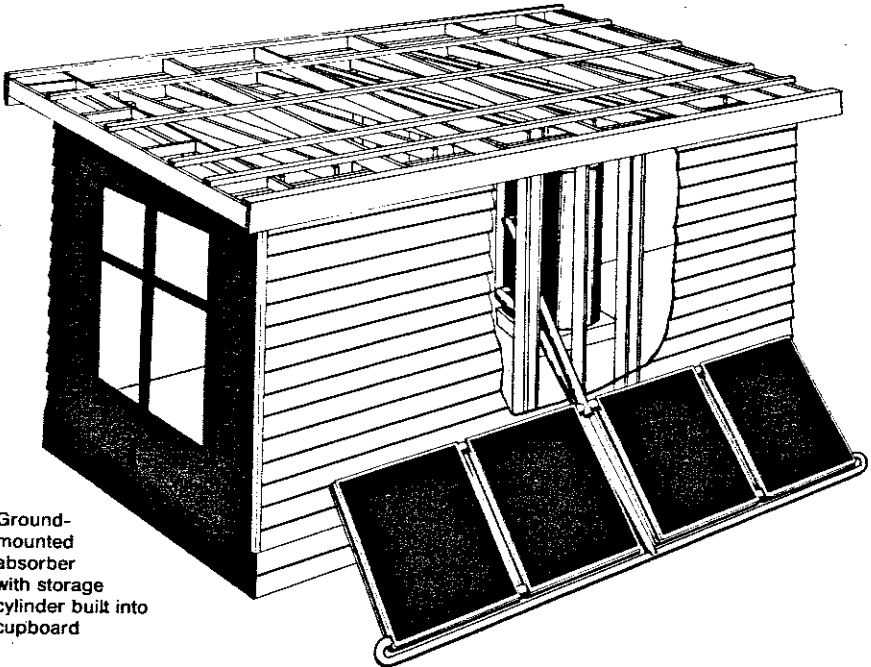

Ground-mounted absorber with storage cylinder built into cupboard

First, you must ensure that you have a suitable spot where you can put a solar absorber. It could be mounted on a roof, above a window awning, or even at ground level, but it should face north and receive direct sunlight all day long.

In addition it should have its horizontal axis east-west and slope at about 10 degrees more than the latitude. A householder in Pretoria (latitude 26°) for example should slope the absorber at 36° from the horizontal while the slope in Cape Town (latitude 34°) should be 44°. Approximate latitudes can be read from the map on page 23.

The shape and location of the house will thus dictate some of the features of the solar heating system. The sketches give some idea of how the house could look when the installation is complete.

Installations in new buildings are generally straightforward because a suitable tank can be purchased at little or no extra cost. Most existing geysers, however, do not have their inlets and outlets in the right place and rather than disrupt a perfectly satisfactory hot water system, the best solution is simply to install an extra tank to pre-heat the water supplied to the geyser.

Solar water heaters can also be added to a system where an appliance such as a solid fuel stove or gas water heater is employed, with a useful saving in fuel.

The following diagrams illustrate the ideas behind some of the arrangements which can be made, full details of which appear later in this booklet.

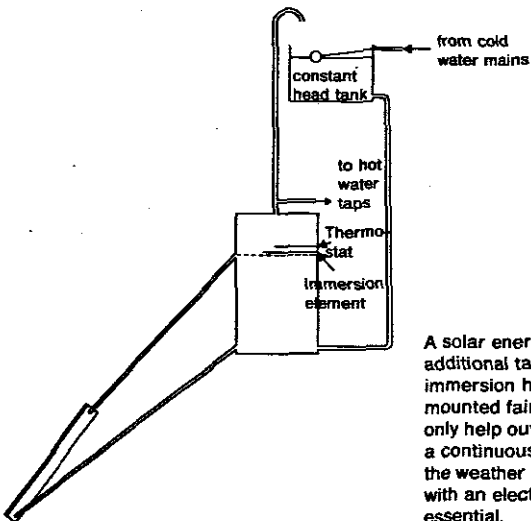

A solar energy system requires a tank with two additional take-off points for the absorber. The immersion heater and thermostat should be mounted fairly high up in the tank so that they only help out on dull days. Most families require a continuous supply of hot water regardless of the weather so that for all normal housing a tank with an electric immersion heater will be essential.

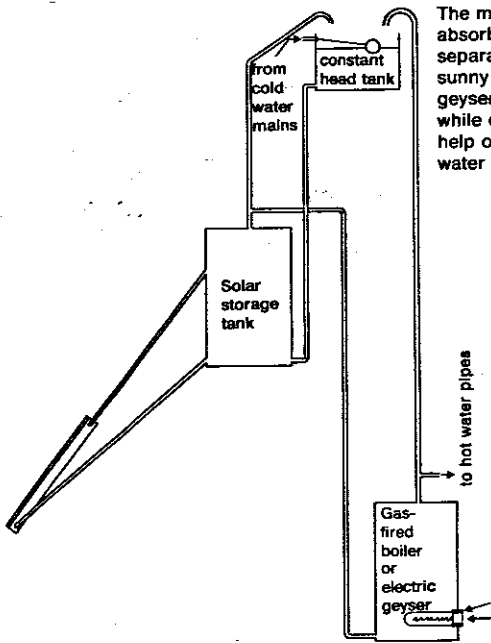

The most efficient way of incorporating a solar absorber into an existing system is to install a separate tank for pre-heating the water. On sunny days the water entering the electric or gas geyser will be hot enough for immediate use while on dull days the immersion element will help out. (See note about instantaneous gas water heaters on page 15.)

A new type of inlet connection has been developed and tested in Australia which enables a solar water absorber to be connected directly into a normal household geyser. Drawbacks are that the heater and thermostat will normally be mounted in the wrong place, making it necessary to use a time switch, and that the tank may turn out to have too small a capacity to make the best use of solar energy.

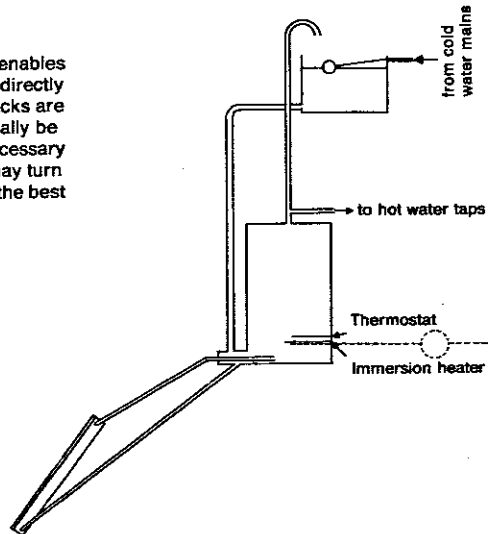

NATIONAL INSTITUTE FOR
 TELECOMMUNICATIONS RESEARCH
 LIBRARY
 13-6-1979
 BIBLIOTEK
 NASIONALE INSTITUUT VIR
 TELEKOMMUNIKASIEAVORSING

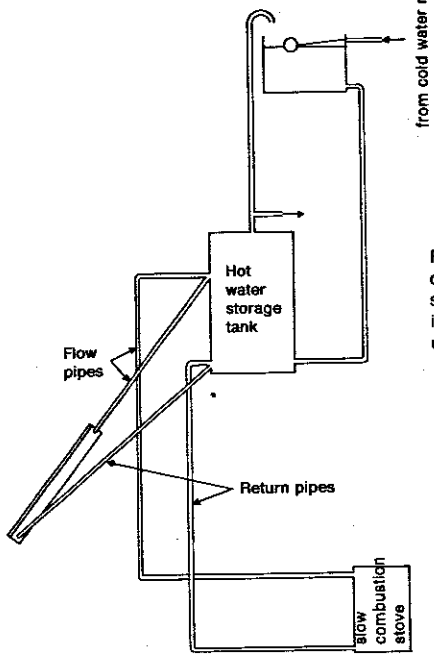

From this diagram it will be seen that the slow combustion stove and absorber both require similar inlets and outlets to the tank which makes it a comparatively simple matter to add a solar unit to such a system.

Previously heated water should not be fed into an instantaneous gas heater. If you wish to use such a heater in conjunction with a solar water heater, the two can be connected as shown in the sketch.

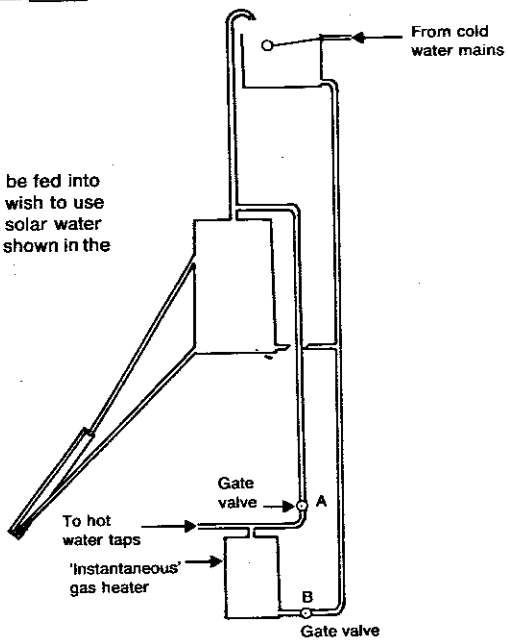

To determine the size of tank that would suit your family simply read off the details from the chart on page 22. Experience will tell you if *your consumption of hot water is above or below average.*

The heating power of the sun varies from one place to another and you should next look at the map on page 23 to find out how many litres per square metre can be heated in your area. If you now divide the tank size that you have just selected by this figure the answer will be the absorber area that you need.

Those who live in the winter rainfall area will have to fit standby electrical heating but they should not let this influence the absorber size unduly because the larger the absorber they fit, the better it will be able to make use of whatever radiation is present in winter. In summer the water will be piping hot.

When calculating the cost of a solar installation you should consider only those items that would not be required for a conventional system such as the absorber and its immediate pipework. The electric geyser, valves and distribution network would be required anyway in a new house so it would hardly be fair to include these in the costing of a solar water heater. A cost of between R50 and R100 per square metre of absorber will not be far out at 1977 prices.

Since a square metre will absorb about 3 kilowatt hours of energy per day – worth about 6 cents – the solar installation can be expected to pay for itself in 3–5 years, less when power costs rise again.

There are firms in South Africa which specialize in the design and installation of solar heating systems. If this is the way you plan to acquire your own installation you are advised to contact several suppliers for quotations. (See current list enclosed with this booklet.)

A well-designed solar water heater will provide about 70 per cent of the hot (60°C) water required. Since the provision of water accounts for about half the electricity consumption in the average home, it follows that a householder will save about 35 per cent on his electricity bill by installing a solar water heater. A rough method of calculating how many years it will take for a solar water heater to pay for itself is to divide the cost by the annual saving, thus:

Cost of installation in rands x 100

35% of the annual electricity consumption in units x unit cost of electricity in cents

The absorber

This is merely a large surface area in contact with the water that we wish to heat. Its construction is based entirely on what we expect it to do.

(i) It must absorb heat well. The surface on which the sun shines is usually painted matt black since this colour absorbs radiation better than others. There are special treatments for metal surfaces which makes them even more effective at absorbing and poorer at re-radiating but these require complicated equipment to apply, and are recommended only for mass-production techniques.

(ii) It must retain the heat absorbed. The hotter the system gets, the more it will tend to lose the heat it has gained. For this reason the absorber must be mounted in a shallow tray with the equivalent of at least 30 mm of glass wool behind it and around the edges. The black absorbing surface will also tend to re-radiate heat so it is necessary to cover the surface of the absorber with a sheet of glass.

The warm rays from the sun, because they are from a bright, high-temperature source, pass through the glass easily as light, but once they have been absorbed their heat can only pass back through the glass by conduction. This is known as the 'greenhouse effect'. There are other materials which can be used but glass is probably the most practical in South Africa.

(iii) It must keep the insulation dry. The box that holds the absorber must be completely watertight because wet insulation does not keep the heat in. Watch out particularly for leaks at the edges of the glass.

(iv) It must be designed to avoid corrosion. The absorber and pipework must not be allowed to leak or corrode since this will rapidly reduce the efficiency of the unit. Most important in this regard is to see that different metals are not allowed to come into contact. A copper absorber should have copper pipes and fittings and should never be allowed to come into contact with aluminium. Plastic fittings can be used to separate different metals.

Copper or stainless steel absorbers are recommended in soft water areas as galvanized steel can be expected to corrode fairly rapidly. (See also indirect system, pages 18 and 28.)

(v) It must resist hail. Broken glass on the absorber will soon admit water and the insulation's value will be lost. To guard against hail breakage a protective screen made from 12 mm chicken netting can be mounted 50 mm or more above the glass. This gap is wide enough to enable the rain to clean the

glass and prevent dirt and leaves from collecting round the screen.

Unfortunately such a screen will reduce the efficiency of the absorber by about fifteen per cent.

To put the risk into perspective the absorber on the roof of the NBRI building has been standing unprotected for nine years and this is covered with normal 5,5 mm plate glass. Those whose insurance policies cover hail damage of this kind may find the risk acceptable.

(vi) It must resist frost. In some parts of South Africa night time temperatures fall to well below freezing point and the absorber by its very nature is extremely vulnerable to damage. There are several ways to protect it. The simplest is to drain the absorber but this is unsatisfactory on several counts not least of which is the extra bother involved.

For those living in frost areas a simple solution is to put an auxiliary heater in the absorber box that switches on automatically when the temperature drops below 4°C. Alternatively if your installation has a pump it will only be necessary to switch this on when the temperature drops. The pump may only run for a few seconds but it will be enough to keep the absorber above freezing point.

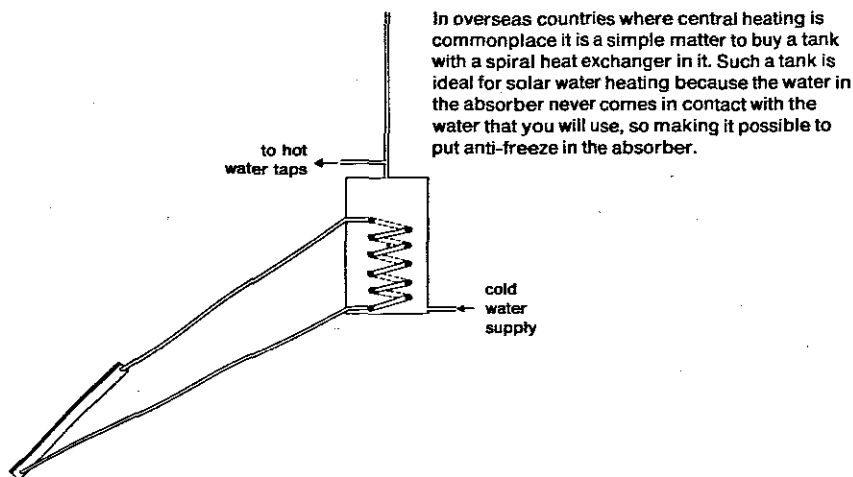

(vii) **It must be economical.** Solar energy is free – but not if you have to invest thousands of rands in the equipment to trap it. Researchers at the National Building Research Institute have built and tested dozens of absorbers of different kinds and have come to the conclusion that at the current price of electricity a solar unit can pay for itself in about five years. Beware of over-investing.

Making an absorber

The following photographs show that absorbers can be made quite effectively from sheet metal of almost any kind.

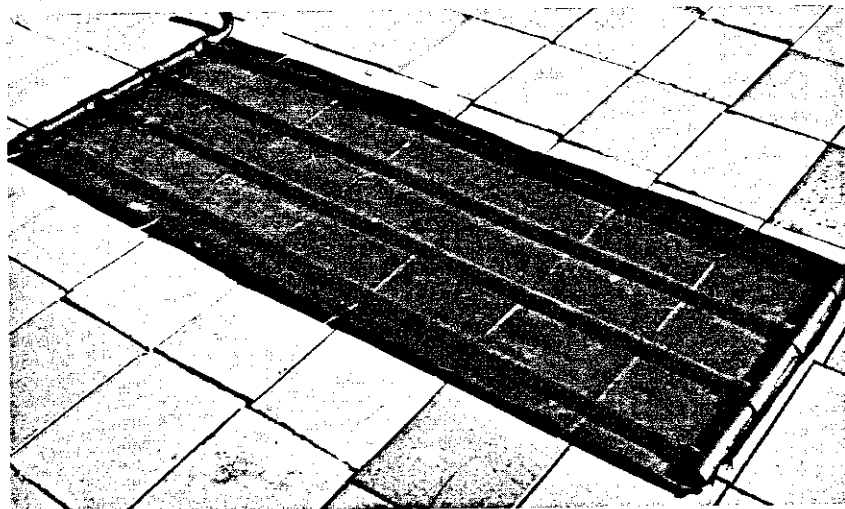
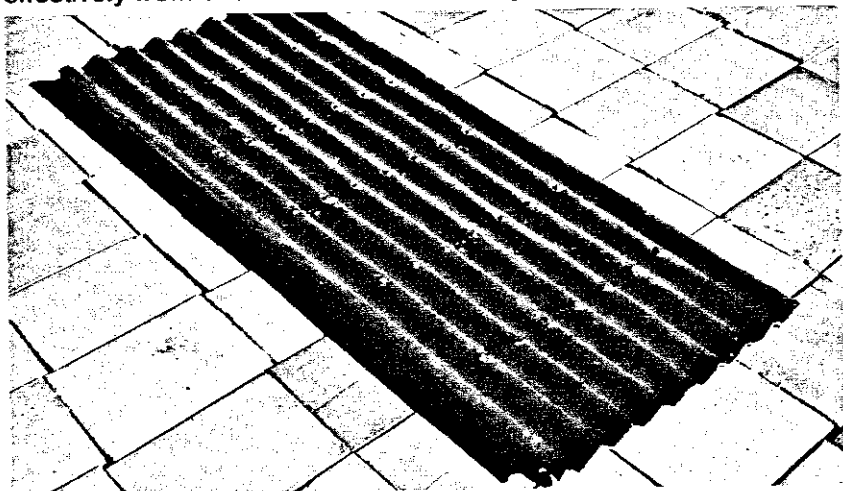



C

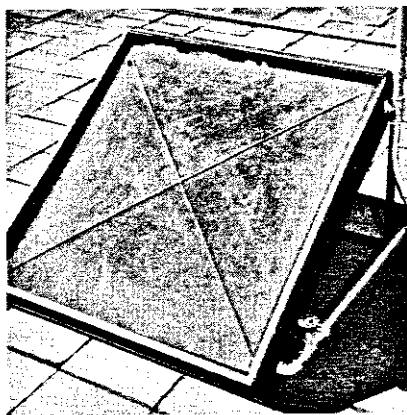

D

E

However, before dashing out to the workshop to begin soldering up sheets of galvanized steel, study the following table.

Comparison of average efficiencies of different absorbers

Type of absorber	Average efficiency (%)
A: two corrugated galvanized steel sheets	50,8
B: galvanized steel pipe framework on copper strips	54,6
C: corrugated galvanized steel sheet on flat galvanized steel sheet	50,4
D: commercial radiator	56,4
E: low-cost unit, galvanized steel	55,9

Highest efficiency comes from a commercial radiator panel (D) which is the simplest of all to assemble. It is recommended on all counts except that it is susceptible to corrosion. Item E, though next highest on the list, loses heat at night.

The next highest efficiency comes from a network of galvanized steel pipes which are in good thermal contact with a metal plate (B). For those who are looking for a practical do-it-yourself absorber this is the one that is recommended, though the man who does not have access to cheap pipe and fittings and the necessary tools will find the total cost approaching that of a ready-made radiator.

Types A and C which are made from corrugated steel sheet have immediate appeal for the handyman because they offer the opportunity to manufacture a functional absorber at very low cost. The snag is that it is no easy task to make them watertight. The bolts are necessary to prevent swelling under the quite considerable water pressure and every bolthole provides a possible leak point. Even after they have been soldered up and tested, any flexing during fitting can open up new leaks in unexpected places.

To ensure the retention of the heat energy collected, the absorber must be well insulated. Asbestos cement trays are manufactured that can accommodate a standard radiator panel. Alternatively, a box can be made from galvanized flat steel sheet or from resin bonded glass fibre. The box must be well made, neat in appearance, and durable enough to protect the absorber for long periods of time. It is important too that it is not too large or heavy – one does not want to have to hire a crane to put the unit on the roof.

This said, the internal dimensions of the box must be at least 20 mm longer and wider than the absorber and 45 mm deeper than the absorber is thick.

Before fitting the absorber, the box should be lined with at least 30 mm of insulation material, such as glass wool or expanded polystyrene sheet. Another alternative (after the absorber has been thoroughly tested) is to use polyurethane foam to fill the space. Two liquids, the monomer and a foaming hardener are mixed and poured into the space below the panel whereupon the mixture foams up to fill the space and then sets hard. The absorber is then permanently attached to the box by the insulation.

The glass sheet (or plastic cover if you are buying a commercial unit) goes on to the top of the box (at least 15 mm clear of the absorber) and is sealed with a silicone sealer to make it weathertight.

As you will lose most of your collecting efficiency if the insulation gets wet, the sealing of the glass and the preservation of the box is of prime importance. Be sure also to seal the points where the pipework leaves the box. Drill a 5 mm hole in the back of the absorber box to prevent pressure building up inside due to air temperature changes.

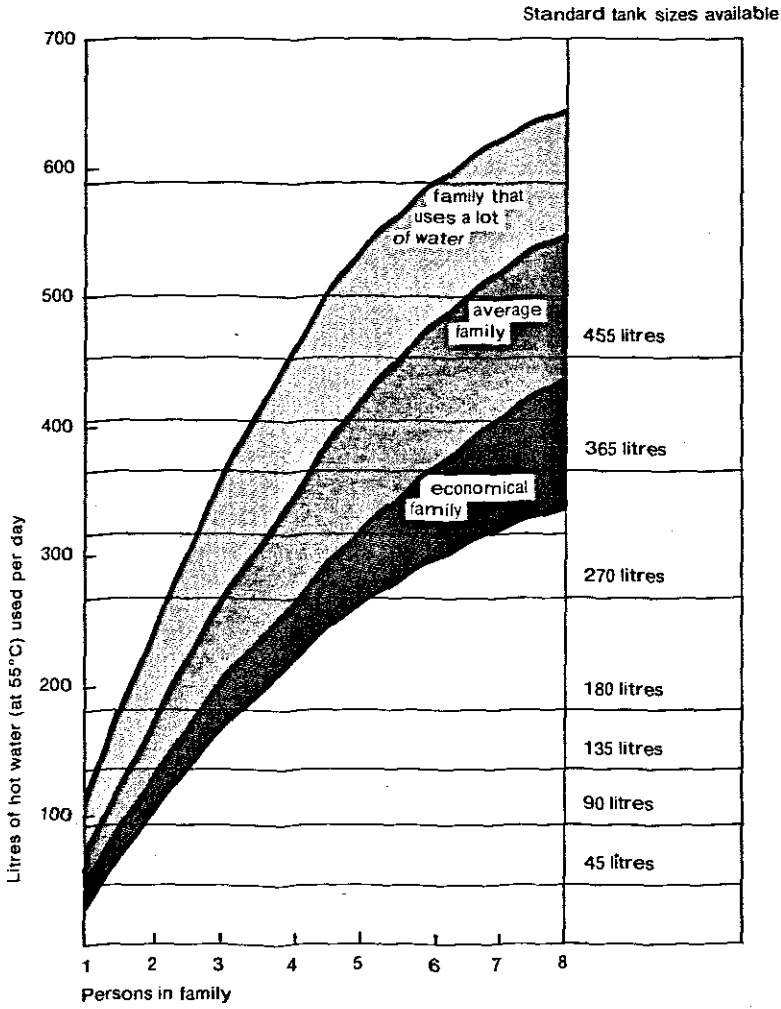

Chart showing typical hot water consumption and tank sizes available (See page 23).

The hot water storage tank

When it comes to installing the water tank, it will be found that there are a large number of types and sizes. The tank is a costly part of the total installation and can be the source of some expensive mistakes so it is essential to think clearly about what you are going to do.

The first requirement is for a tank that is large enough. It is no good looking at your existing geyser because this has 24 hours in which to do what your solar heater must do in eight. The chart opposite shows typical hot water consumptions for some average South African families. Once you have estimated your hot water needs, you can, from the same chart, estimate the size of solar water tank that best fits your needs.

The map below gives some idea of how much water can be heated by a square metre of collector in different parts of the country and from it you can work out the absorber area that you require.

For example, suppose a family of five living in the Kimberley area would like to have enough solar heated water that they only rarely had to rely on electricity. If they used a minimum amount of hot water they might select a 270 litre tank. In Kimberley one can heat 70 litres of water per square metre. So the necessary absorber area would be about 4 m².

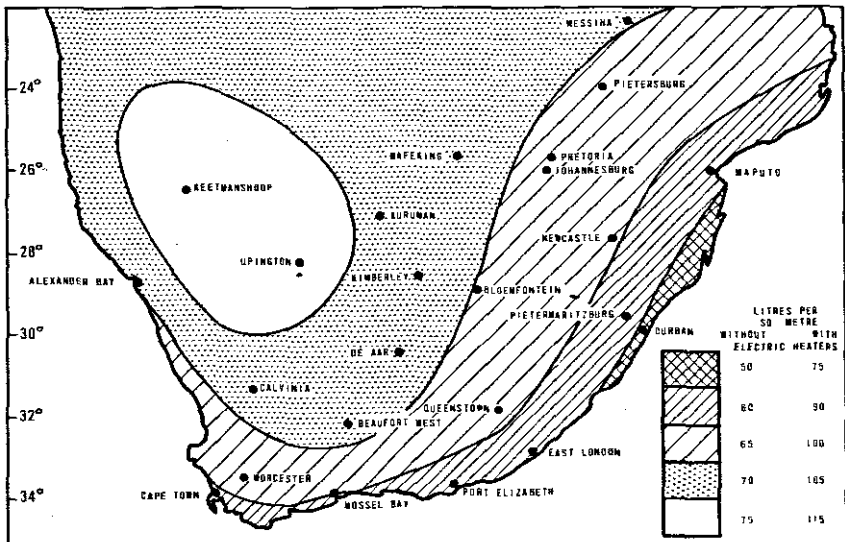

Solar water heating potential of different areas of South Africa (See text above).

If the same family were thinking of adding an absorber to an existing geyser, they would add a 270 litre solar storage tank to their present electric geyser system.

For a new installation

An ordinary electric geyser is not suitable for use as a storage tank for solar-heated water. This is because:

1. It does not have the necessary connections for the solar absorber.
2. It may not have a baffle to prevent the mixing of the inlet water with that which has already been warmed.
3. The heating element and thermostat are mounted at the bottom of the tank. This is done so that as soon as any hot water is drawn the electric element commences to heat the replacement water. Not only is this undesirable in a solar installation where one is planning to save electricity but it immediately reduces the thermo-syphon circulation through the absorber. (See page 25.) For solar applications the element should be mounted two-thirds to three-quarters of the way up the tank where it acts only as an emergency heater to prevent the household from running short of hot water on dull days.

Suitable tanks are available in South Africa and can be installed in a new building for more or less the same cost as a standard geyser. Low-cost are usually supplied uninsulated and must be efficiently lagged once they have been installed. This is easily done with a 50-80 mm thickness of mineral wool or glass fibre held in place with plastic sheeting, chicken netting or a canvas jacket.

If the tank must stand in the open the insulation must be thoroughly protected. There are several ways of doing this but most do not last long in the open. The best way is to enclose the insulated tank in a galvanized steel jacket.

For an existing system

Because the existing geyser will almost always be too small for solar use, an extra tank of a capacity equal to your total requirements should be purchased. In this case no electric element will be needed.

The second tank will be piped into the system as in the top diagram on page 14. It will be seen that it can be situated at any point below the header tank but above the absorber.

When hot water is drawn from the geyser it will be replaced by hot water from the solar storage tank so that the immersion heater will

not switch on until all the hot water in the solar tank has been used up.

There is a method of connecting a solar absorber to an existing geyser but it is unsatisfactory on two accounts. First the capacity of the tank will usually be too small, and because the thermostat will be at the bottom of the tank it must be controlled through a time switch. If conditions dictate this type of installation you should write to the NBRI for further instructions.

Beware of horizontal tanks! Tests have shown that unless a baffle is installed the cold water causes turbulence when it enters with the result that whenever a hot water tap is opened, the temperature of the hot water remaining in the tank drops excessively.

Combination geysers can also be satisfactorily modified. The header tank should be removed and the hot water supply from the solar system should then be connected to the outlet of the geyser at the point where this previously left the header tank. Pressure in the system must be regulated by a pressure control valve fitted to the cold water pipe supplying the solar system.

The pipework

As the hot water rises in the system it starts a pattern of circulation that is known as a thermo-syphon. In this way the less dense warm water rises into the top of the storage tank and denser colder water at the bottom of the storage tank passes down into the absorber. However the difference in density that drives the water around is very small indeed and it does not take much to stop the circulation. The thing that is responsible for most failures in solar water heaters is its pipework that allows airlocks to form.

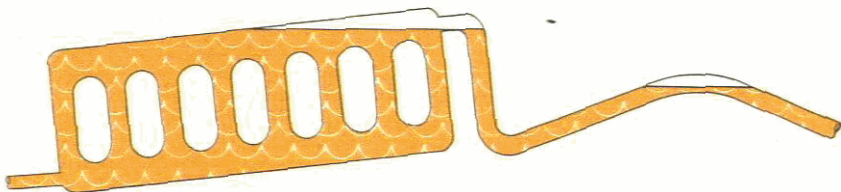

Any airlock will be enough to halt circulation completely so it is clearly very important to ensure that all hot water pipes running from the absorber to the tank slope gently *upwards* so that any air that comes out of solution as the water warms can escape via the vent pipe above the tank.

Another important point in connection with the pipework is that friction within small bore pipes cannot be neglected. The driving power of a thermo-syphon is also directly related to the height of the hot water tank above the absorber and where this force alone is to be relied on to circulate the water, then some strict dimensional rules should be adhered to.

1. The minimum number of pipe fittings should be used. Because the pipes will be clad in insulating material and shielded from the sun flexible plastic piping can be used. However it must be nylon reinforced PVC hosepipe preferably to SABS specification 1086 and should be supported in such a way as to prevent kinking and drooping.

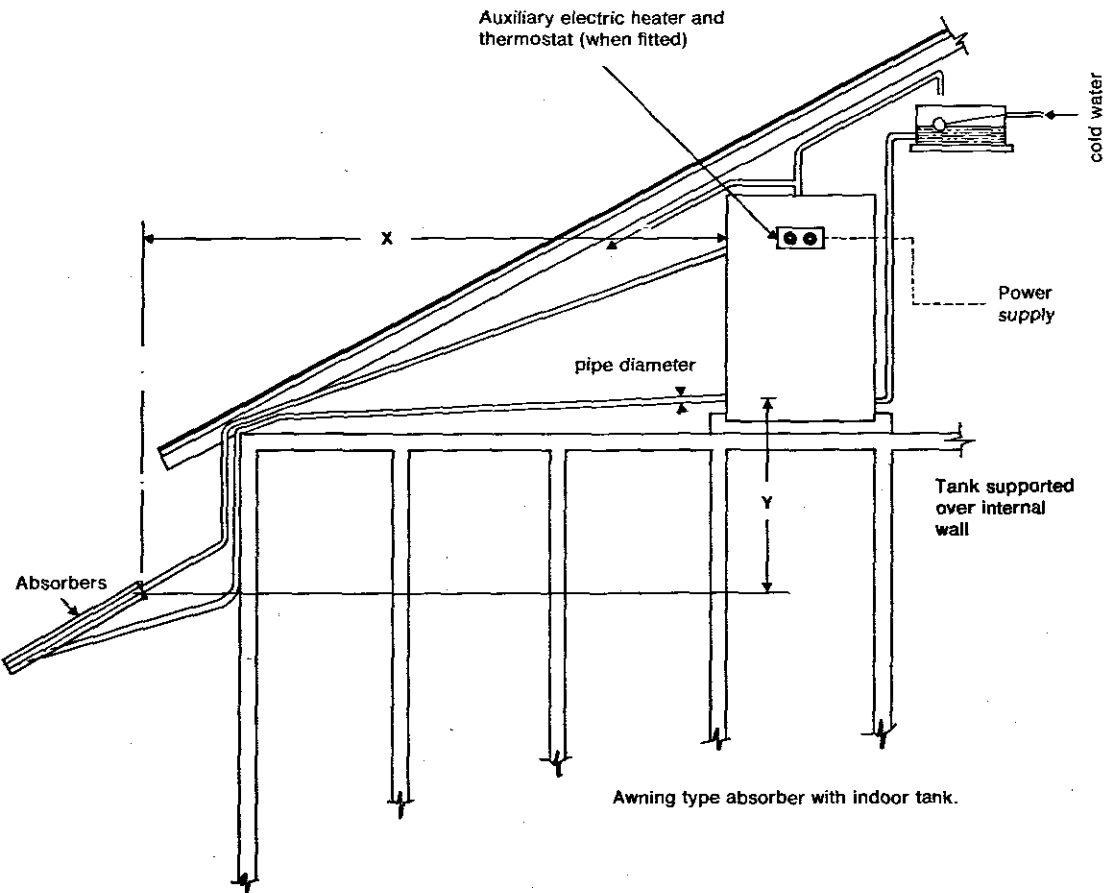

- The bottom of the tank should be at least 600 mm above the top of the absorber.
- The longer the lengths of pipe used the larger their diameter should be. The correct dimensions can be calculated from the tables below.

Absorber area 10 m ²			
Y	X		
	1,5 m	3,0 m	7,0 m
600 mm	40	40	40
1,5 m	32	32	32
3 m	25	25	32

Absorber area 5 m ²			
Y	X		
	1,5 m	3,0 m	7,0 m
600 mm	25	25	32
1,5 m	25	25	25
3,0 m	25	25	25

Recommended internal pipe diameters (mm) for different values at X + Y.
(Dimension Y should at least be 600 mm.)

Forced circulation

Where the absorber has to be mounted above the hot water tank, a thermo-syphon cannot operate and it will be necessary to use a small pump operated by electricity (approximately two watts per square metre of absorber) to circulate the water.

The most important thing is that the head of water should be above the top of the absorber and this can be achieved either by raising the header tank above this level or by using a pressure control valve.

Do not forget that all water loses dissolved air on heating and that where the tank is below the absorber both must be vented if airlocks are to be avoided.

The sketches below and on page 28 show various arrangements.

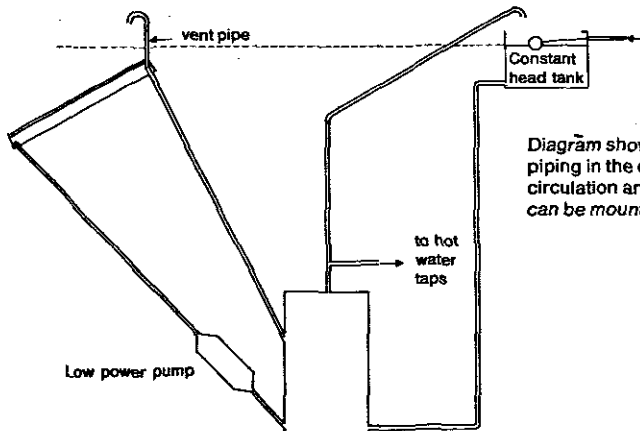
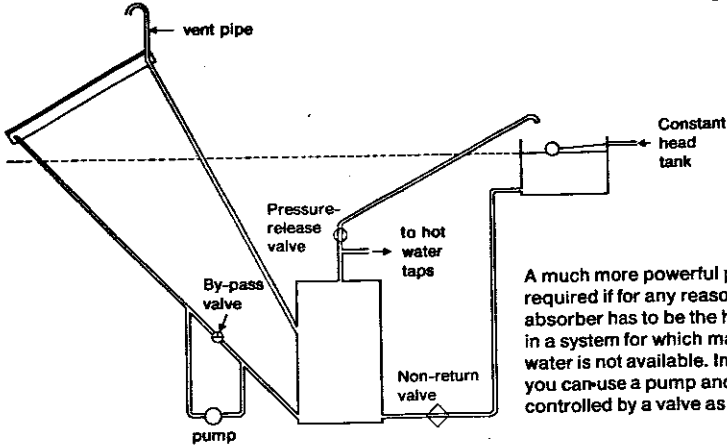
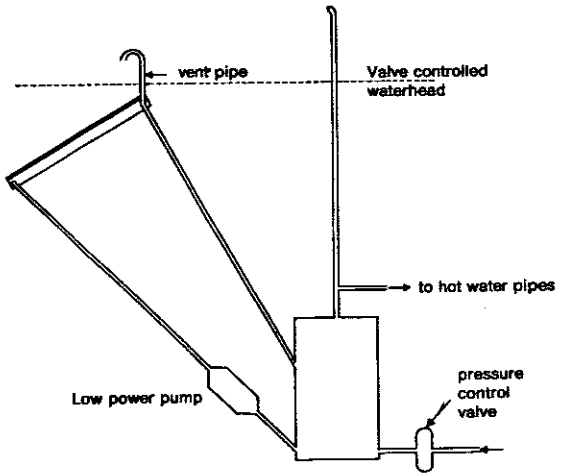
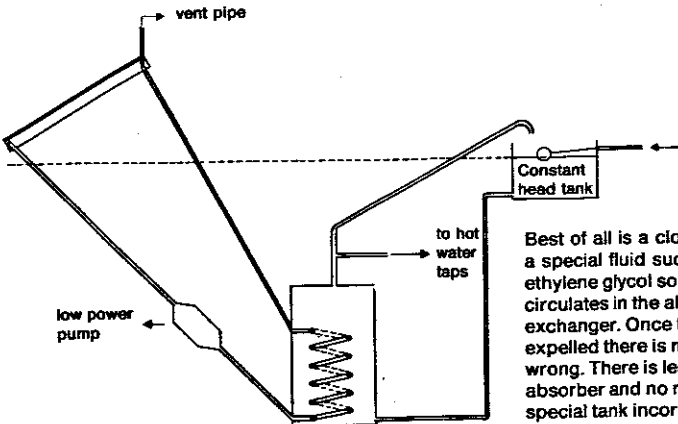

Diagram showing arrangement of piping in the case of forced circulation and where a header tank can be mounted above the absorber.

Diagram showing arrangement of piping in the case of forced circulation and in which mains pressure is used to maintain a head of water in the absorber.



A much more powerful pump is required if for any reason the absorber has to be the highest point in a system for which mains pressure water is not available. In such a case you can use a pump and by-pass controlled by a valve as in this sketch.



Best of all is a closed system in which a special fluid such as a 25 per cent ethylene glycol solution (anti-freeze) circulates in the absorber and heat exchanger. Once the air has been expelled there is much less to go wrong. There is less rusting in the absorber and no risk of freezing. A special tank incorporating a heat exchanger is required for this system.

So far forced circulation has only been mentioned in connection with absorbers that are mounted above the level of the tank. However the use of very low power pumps (about two watts per square metre of absorber) has a great deal to recommend it in some situations.

A major disadvantage is that one has an expensive extra moving part which requires additional maintenance and controls.

The controls consist basically of what is known as a differential thermostat. Thermistors are installed in the fittings at the top of the highest absorber and in the bottom of the storage tank. These sense the difference in temperature between the water before and after it has passed through the absorber. As long as the latter is at least 1,5°C higher than the former the pump continues to circulate but it shuts down the moment there ceases to be enough heat gain. Such a sensitive device ensures that one collects as much solar energy as possible with minimum losses. A circuit diagram and basic instructions for making a differential thermostat can be obtained from the NBRI on request.*

The thermistor in the absorber is also set to switch on the motor when the temperature drops below 4°C. This prevents frost damage, by circulating warm water for a few seconds every time the absorber gets too cold.

A space-age development is a small pump powered entirely by solar cells. The brighter the sun gets the faster it circulates the water while as the sun goes behind a cloud the pump slows down. These devices are fairly expensive to buy but cost nothing to run.

Maintenance

The efficiency of any solar water system will depend very largely on the glass being intact and the insulation dry.

It must be checked regularly – preferably once a month – to ensure that the glass is unbroken, that the sealant is still sound, that beadings and edge trims are not coming loose, that the pipework insulation is still well protected and that the paint is sound. A glance at the absorber from the ground will suffice for three months out of four.

If the absorber is not made of copper or stainless steel it must be checked to see that it has not rusted through in places and that water is not leaking into the insulation. Excessive condensation inside the glass is a danger signal. (See page 17 for note on corrosion.)

*Write to the Director, NBRI, P.O. Box 395, Pretoria, 0001.

Part III – Making a solar water heater

Step-by-step picture guide

The following steps describe the construction of a solar water heater for use in houses with either flat or sloping roofs. The materials shown in the photographs and listed on page 39 have been chosen for the ease with which they can be obtained and assembled, and the NBRI recommends this method of building a home solar water heater to any competent handyman. The only disadvantage is that the steel radiator panels themselves are likely to corrode badly enough to leak after three to five years. They will then need replacing but their cost is relatively small and the replacement should take no more than two hours for a two radiator installation.

The pitched roof system photographed has 3 m² of absorber (radiator panel) area. This is enough for an average family.

Steps 3, 10, 11 and 12 fall away if a solar absorber is bought already assembled. Information about suppliers of solar absorbers and components for a solar water heating installation is available from the NBRI, and a current list of suppliers accompanies this booklet.

1. Examine the north-facing roof area of your house and decide where the collector panels and storage cylinder should be placed.

2. To design a system the right size for your family, look at the section on pages 22-24. Decide whether to buy components or a pre-assembled solar absorber.



3. Paint absorber panel with a matt black acrylic emulsion paint.
4. Make up support platform for storage cylinder and install cylinder.





5. Place asbestos cement tray on roof. If more than one panel is required, assemble pipe fittings to establish position of other trays (see page 38 and step 13).

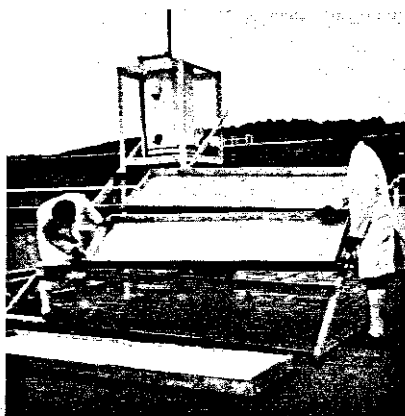

6. The equivalent for a flat roof. Various absorber panel layouts are shown on page 38.

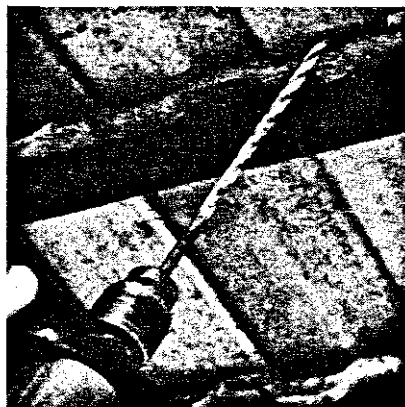

7. Drill hole for hook bolts from beneath roof and just above brandering. Use masonry drill.



8. Secure tray with hook bolt. Seal hole with silicone sealer.



9. Tray can also be secured with steel strapping. This can be slid between overlapping tiles and saves drilling through tiles.

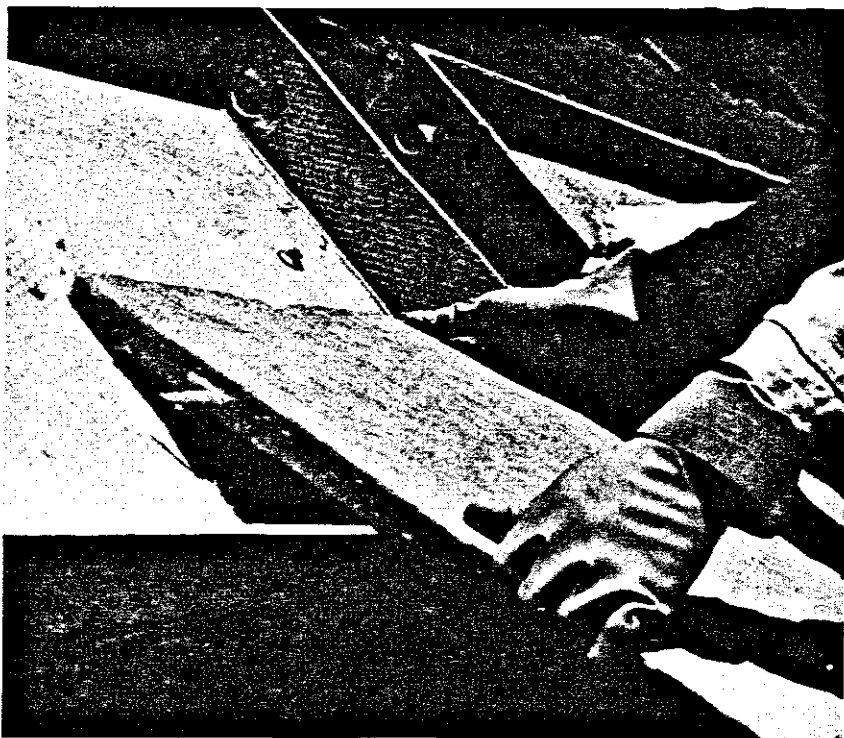

10. Using rubber gloves, place 40-mm-thick sheet of glass-fibre or polystyrene insulation in tray.

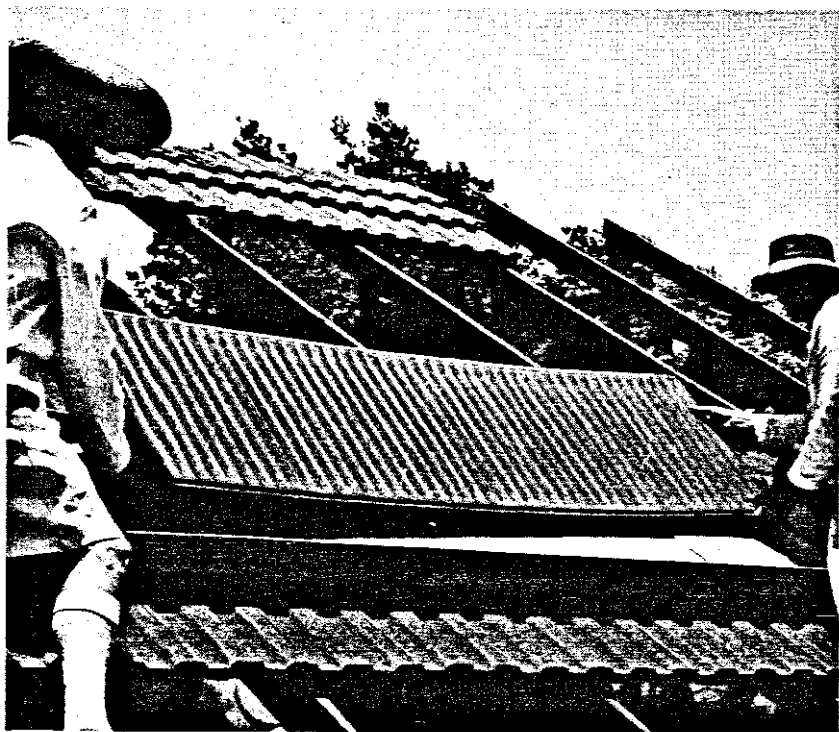

11. Lay absorber panel on top of insulation.

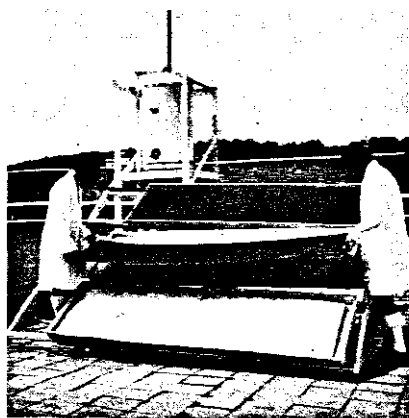

12. The equivalent for a flat roof.



13. Remove tile and fit interconnecting pipes.

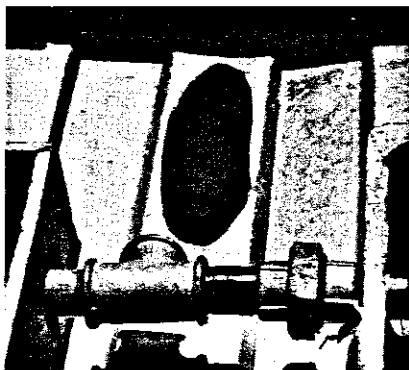

14. Insert flashing.

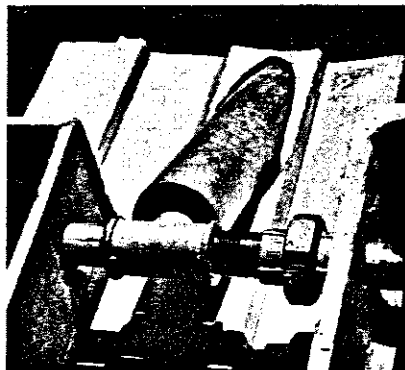

15. Place steel muff over riser pipe, which can then be screwed into T-junction.

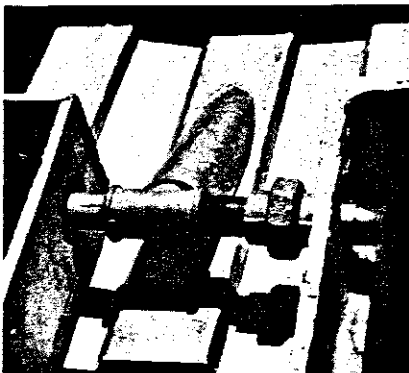

16. Solder muff to flashing.



17. Fixing on an IBR or corrugated steel roof can be done by cutting a slot with a cold chisel and using a steel pipe to form a depression.



18. Pass hosing or steel pipe through hole and seal with silicone sealer.



19. Place flashing over pipe.



20. Bolt flashing in position and push insulation under flasher.

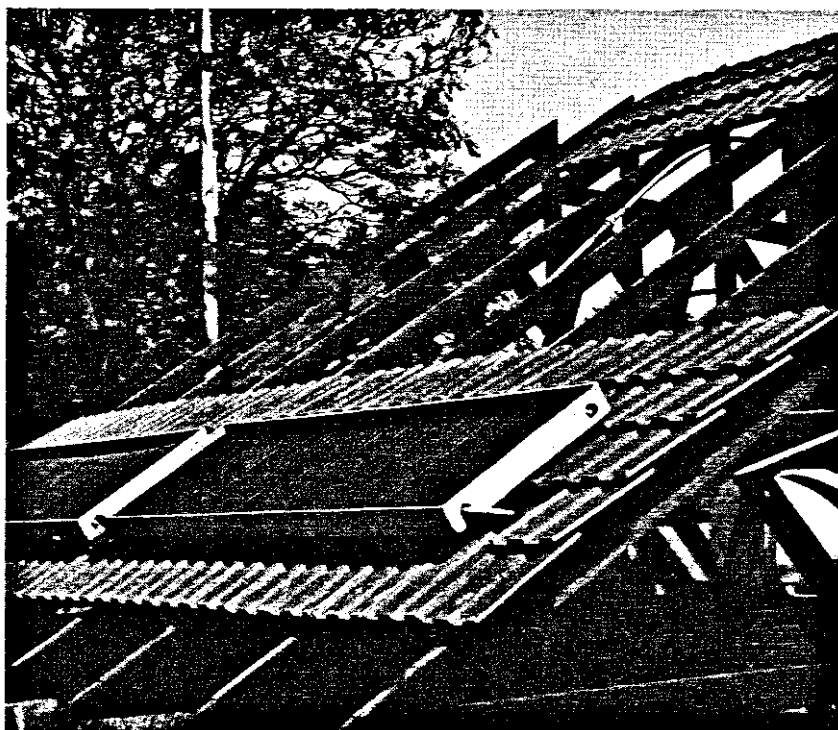

21. Connect flow and return pipes to storage cylinder outlets.

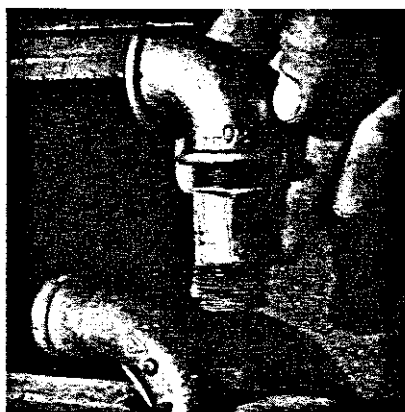

22. Use minimum number of fittings and use bends and not elbows so as to reduce pipe friction losses.

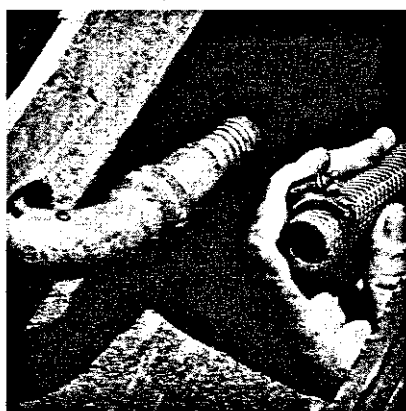

23. If nylon reinforced hose pipe is used, use steel (and not plastic) swage nipples secured with hose clamps when making connections to absorber panel and storage cylinder.



24. Turn water on when all pipes are connected and stop any leaks.



25. Spread silicone sealer along top edge of asbestos cement tray.

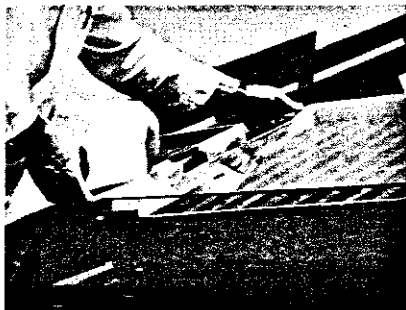

26. Lay glass in position and depress so that sealer makes contact along the entire interface between glass and asbestos cement. Use a small bracket or masking tape to stop glass from sliding down and remove when sealer is dry.



27. Position adjacent sheets of glass within 1-2 mm of each other and fill this gap with silicone sealer.



28. Cover flow and return lines with glass-fibre or polystyrene insulation. Any exposed insulation should be covered with steel muffs.



29. Insulate storage cylinder with 80-100 mm thickness of glass-fibre or mineral wool.

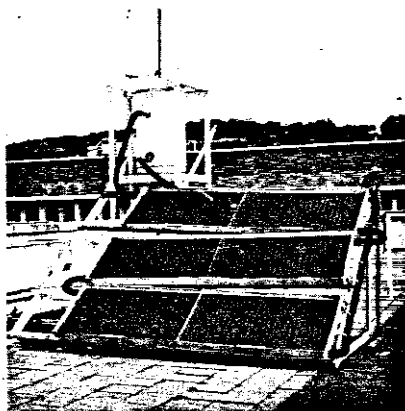

30. . . . and the job is done.



31. The completed job for a sloping roof.

Schematic layout of pipe connections to absorber panels

1. Cold water supply from bottom of storage tank to lowest point on absorber panel.
2. Hot water return from top of absorber to connection two-thirds up the storage tank.

Single absorber panel

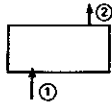

Two absorber panels

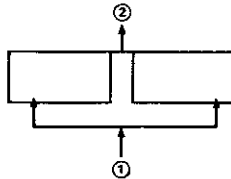

or

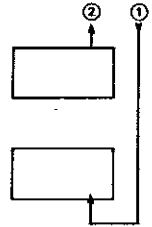

Three absorber panels

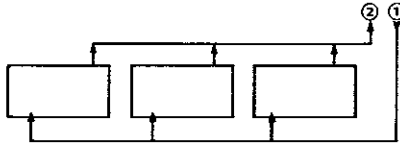

or

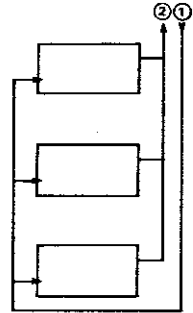

Four or more absorber panels

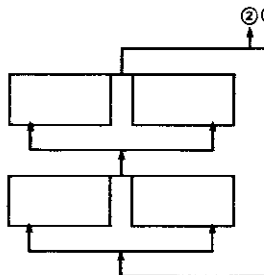
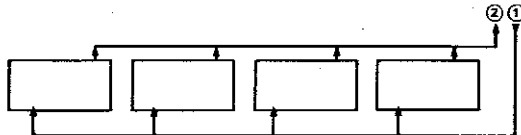

Check-list of components

Item	Size (mm unless otherwise specified)	No. of items required for one, two or three panels		
Absorber				
Commercial radiator panel	2 500 x 610	1	2	3
Asbestos cement tray	2 535 x 645 x 90	1	2	3
Glass	1 275 x 680 x 4-6	2	4	6
Insulation	40 mm thick glass-fibre in roll or 28 mm thick polystyrene in sheet form	1,6m ²	3,2m ²	4,8m ²
Hose adaptors	20 ϕ (ϕ =mm diameter)	2	4	6
Hose clamps	20-30 ϕ No. 4	2	4	6
PTFE thread tape	Roll	1	1	1
Plugs	20 ϕ	2	4	6
Silicone sealant	Tube	1	1	1
Matt black acrylic emulsion paint	500 ml can	1	1	1
Hot water storage tank				
Storage tank	For capacity see pages 21 to 24	1	1	1
Insulation	40-50 mm glass-fibre or mineral wool in roll	2,5m ²	3m ²	3,5m ²
Hose adaptors	20 ϕ	2	2	2
PTFE thread tape		Remainder of roll for absorber adequate		
Hose clamps	20-30 ϕ No. 4	2	2	2

Piping

Galvanized steel piping or nylon reinforced PVC hose pipe (SABS specification 1086) of suitable diameter (see page 27) and length to suit installation conditions.

Elbows and nipples to suit installation. Polystyrene or glass-fibre insulation 50 mm outside diameter by 25 mm inside diameter to suit installation.

Hose clamps 45-60 ϕ No. 13 at 1 metre spacing.