

Rural Water Tanks with HFB Technique

TECHNICAL GUIDE

by Felipe Solsona



Water
Technology

CSIR

Rural Water Tanks with HFB Technique

TECHNICAL GUIDE

by

Felipe Solsona

MSc Eng

PRETORIA

March 1991

ABSTRACT

In extended areas of the world water is so scarce that for many people the possibility of storing drinking water is of vital importance.

A water tank for use in rural or peri-urban areas of developing countries should be easy to build using unskilled labour, strong, have a long life expectancy, be resistant to chemical attack by water and/or atmospheric agents and have the flexibility to be constructed to various depths and sizes. Although there are a variety of techniques actually in use, in general few of them satisfy the above-mentioned conditions.

This Technical Guide describes a very simple technique for water tank construction called H-F-B (heart filled blocks). The technique makes use of a simple mould (which can be made even in rural areas) for the manufacture of concrete building blocks. The block production is easy and requires the use of neither energy nor skilled workmen.

The laying of the blocks to construct the tank is non-conventional. The blocks are simply placed one on top of the other without the aid of mortar, and then, at intervals, a slurry of soil-cement is poured into the top, filling the hollows and producing a monolithic structure.

CONTENTS

	<i>Page</i>
1. INTRODUCTION	1
2. THE HFB TECHNIQUE	3
2.1 Selection of the place	4
2.2 The slab	4
2.3 The blocks	5
2.4 The cover	10
3. CONSTRUCTION TECHNIQUES	11
3.1 The slab	11
3.2 The blocks	14
3.3 The tank	32
3.4 The cover	39
4. TIME CONSIDERATIONS	40
5. TOOLS	41
6. INTO OPERATION	43
7. MAINTENANCE	44
8. SUMMARY OF RELEVANT INFORMATION	46

Printed by Scientia Publishers, CSIR

GAcSir 67016014*9106

1. INTRODUCTION

Man depends on water.

In many parts of the world, people living in rural or squatter areas spend considerable time in the task of providing water for their needs. The fetching of water, the coming and going from home to the water source, is for millions of people living in developing countries the main task of their lives.

In some African countries people travel miles and miles during a whole day with their cattle, donkeys and empty containers to a borehole. There they queue for hours or even day to water the cattle and fill the containers. Finally they go back home with the precious but scarce load to leave the water there. The next day the whole cycle is begun again.

The solution to this widely spread problem is to get a water-source nearer to the dwelling and to have the capacity to store water.

Unfortunately in some extended areas water is so scarce or often so difficult to reach that the first option is impossible. The possibility to mitigate the problem, then lies in the capacity to store water.

Provided there are enough small containers and a convenient transporting facility, a good storing element will save a number of trips to the water source and the corresponding time. If the storing element is of convenient size and if there are abundant rainfalls in the area, then a new, easy and affordable way of getting the vital liquid has been achieved.

It is with this short but very objective and realistic introduction that the importance of the water tank for millions and millions of people has been highlighted.

In some areas of the world, water tank construction using local materials is a common practice, but the fact is that in general the “tank technique” is often poor and presents several flaws.

The reason is that a reliable water tank should meet the following conditions:

- Easy to build in rural or squatter areas
- Use materials locally available
- Strong and with a long life expectancy
- Resistant to attack by water and/or atmospheric agents
- Affordable
- Easy to maintain

It can be said that in general few techniques, if any, satisfy the above mentioned conditions. Among the different ways of building a water tank, the use of ferro-cement with or without the use of moulds, and the walls raised with bricks, blocks and/or masonry are amongst the more traditional techniques.

The Heart Filled Block (-HFB-) technique corresponds to the second kind. Nevertheless, it presents an innovation, and practice has proved this technique to be very simple in concept and easy to develop. No skilled personnel are required. The tanks have a high performance and durability and are very quick to build. The technique doesn't make use of energy and present reasonably low costs.

2. THE HFB TECHNIQUE

The HFB technique falls into the block constructed walls category.

The heart filled block is a specially designed hollow block that is prepared using a metal or wooden mould.

The moulds (and consequently the blocks) can be either straight or curved thus allowing the construction of rectangular or circular tanks.

The tank construction begins with a standard supporting slab. Once the slab is settled, the blocks are placed one on top of the other without the aid of mortar. After every second row, a slurry of sand-cement or soil-cement is poured over the top, filling the interconnected hollows and producing, when cured, a monolithic structure.

This innovative part of the technique is very quick and does not even require personnel with brick laying skills. Provided the slab is ready and the blocks already produced, the walls of a 5 m³ tank can be built in a few hours. A height of 2 m is the maximum recommended for structural reasons and for ease of building. Inside plastering will ensure protection against leakages.

A cover to prevent contaminations can be made from local materials or even a thin concrete lid will be the last item for the structure.

Outside plastering and/or painting are optional to improve the tank appearance.

2.1 Selection of the Place

The selection of the place to build a water tank is very important, although no fixed rule applies to it. Nevertheless, common sense will be the best aid when choosing the site to a tank.

If the tank is going to gather rain water, it obviously will be located near the catchment area (normally the house roof).

The place for installing the tank should be as near as possible to the house but without interfering with pathways and social or communal activities sites.

House walls and trees can provide shade in order to keep the water as cool as possible. The tap should face the kitchen or the site of use of the water. This will make a shorter trip to fetch the water.

2.2 The Slab

The slab is the supporting structure for the tank and its water-content.

Depending on economic possibilities and on soil conditions, the slab will have an iron-reinforcing structure or plain concrete mixture.

A standard iron-grit will ensure strength and stability against the pressure of the water and against light soil movements.

A height of 15 cm is convenient for structural strength.

The slab should be between 20 and 40 cm wider than the tank diameter (if round) or than the external sides of the walls (if rectangular or square).

2.3 The Blocks

Being the heart of the system, it is important to spend some time in the discussion of block characteristics.

The blocks are standard as regards the building materials (cement-sand-gravel).

The innovation lies in the shape and the position of the holes.

As these blocks are not laid with mortar interconnecting them, but placed freely and loosely one on top of the other, it is very important that the holes of the blocks in a certain layer match with the holes of the corresponding blocks in the upper and lower layers. This will allow the slurry to fill all the free spaces interconnecting them and thus form the monolithic structure.

An example of the holes and their interconnection can be seen in Fig 1.

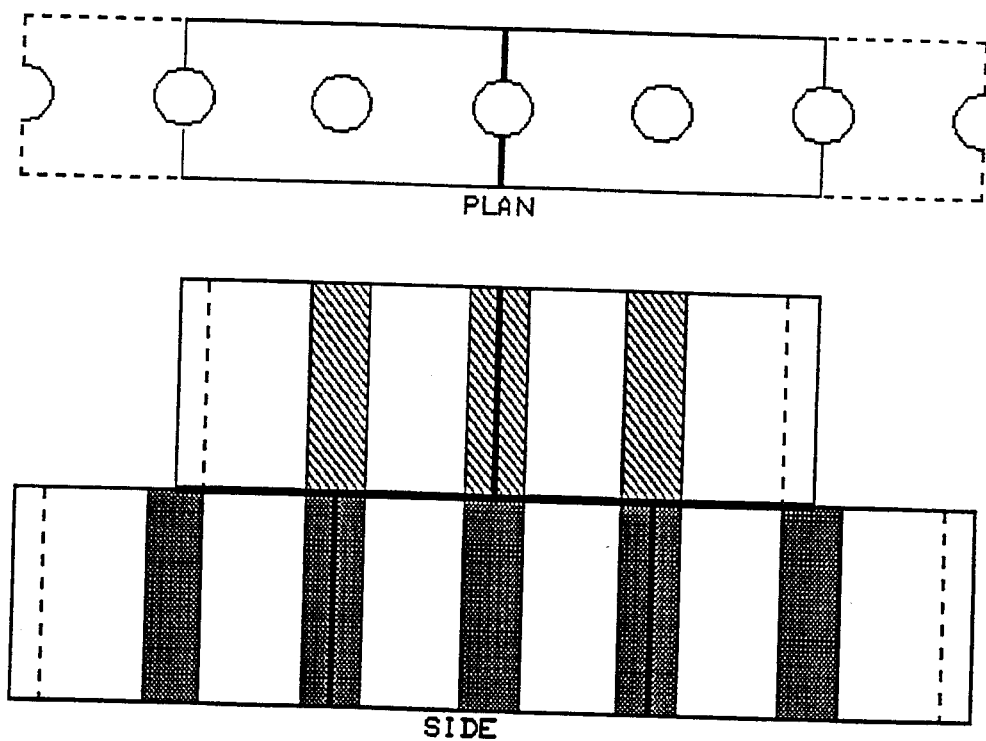

Figure 1: Interconnecting holes

Provided this important condition is maintained, any shape and size of holes can be used when designing the mould for the blocks.

The practical number of holes in a block is either 3 or 5. These holes should be placed two at the ends and one at the centre. This is a condition for the holes to correlate with upper and lower block holes. Therefore the minimal number of holes for a block is 3.

If the block is big enough (e.g. 40-50 cm) then two additional holes can be made between the central and the end holes. Thus the total number will be increased to 5 holes.

Bigger blocks (that would allow more holes) are impractical to produce and handle. As regards the size of the holes and the block wall thickness, it can be said that the best and cheapest block is the one with the thinnest walls. The reason is that if the block walls are thin, less mortar is required for the construction and more slurry is used later. The mortar is expensive, the slurry cheap. In addition big holes will allow a fluid slurry passage and interconnecting, and finally, a block with thin walls is easy to handle, lift and place in the tank wall.

Nevertheless, it should be considered that no block wall should ever be thinner than 2.5 cm.

Two general shapes of blocks can be used: curved or straight and rectangular. The first will allow the construction of circular tanks, the second square or rectangular tanks.

Circular tanks have the advantage of presenting higher structural strength. The disadvantage lies in the fact that with a curved block, only a tank with a fixed diameter can be built.

The advantage of the rectangular block is that it allows the construction of tanks of different sizes. Another important characteristic is that a rectangular mould can be produced in any place. The drawback is that square or rectangular tanks are less strong and more susceptible to develop cracks due to water pressure.

The moulds can be made either of mild steel or strong wood.

Thickness of steel 2 mm

Thickness of wood 10 mm

The pieces to produce the holes can be made of iron, wood, PVC piping or iron piping.

Any shape is allowed, but obviously circular or square are recommended. Top handles in these pieces will help the production of blocks.

Finally, and in relation to the block size, practical reasons condition the length to a minimum of 30 cm and a maximum of 50 cm.

If the shape is rectangular, then it is important to produce a block with a:

Ratio length:width 2:1

Height 20-25 cm

Fig 2 - 5 present different moulds, hole pieces and the corresponding blocks. "Corner blocks" will be explained under block construction

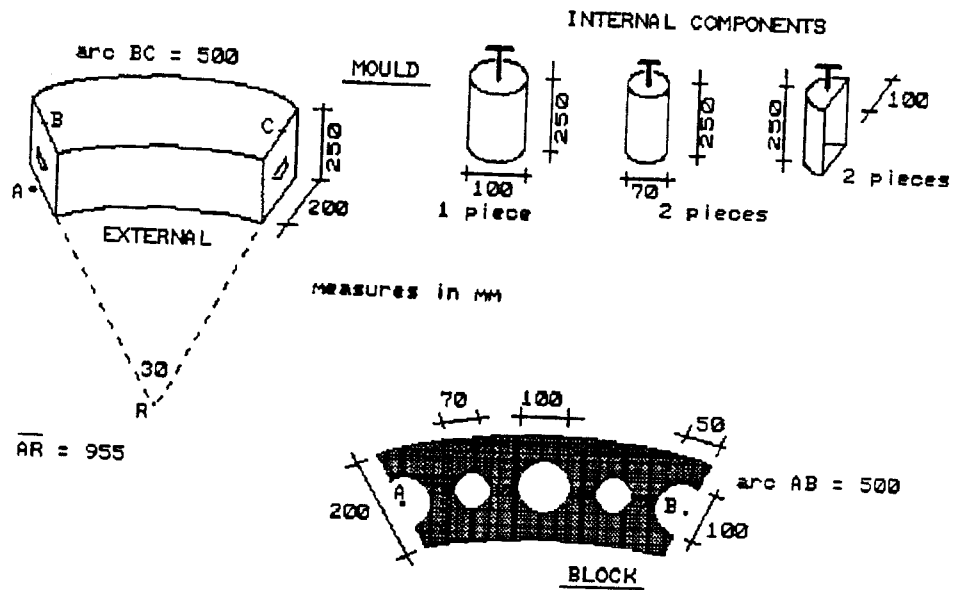

Figure 2: Curved block. Hole-pieces from piping

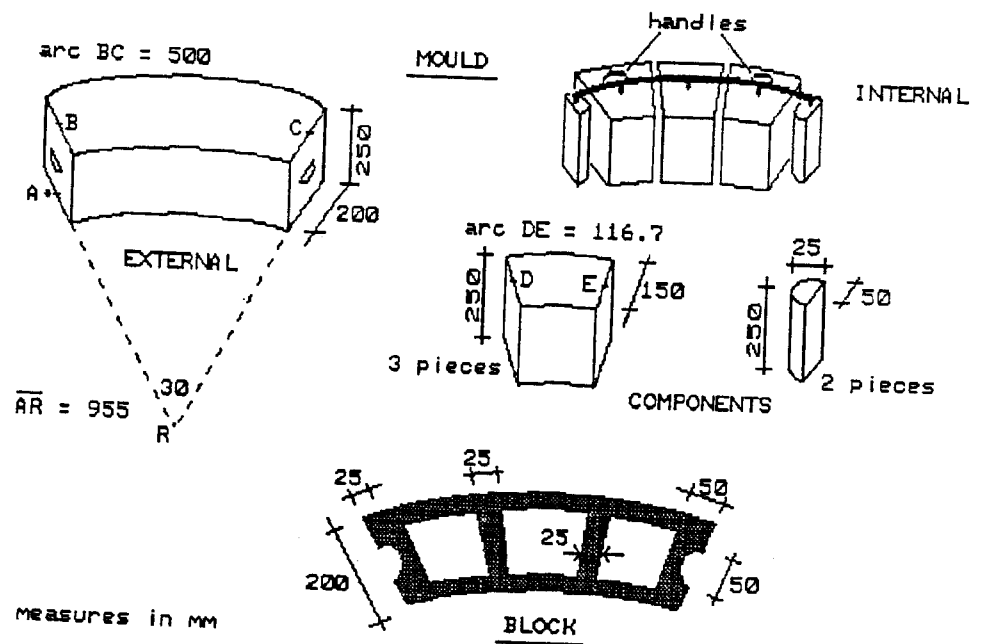

Figure 3: Curved block. Hole-pieces from rectangular moulds

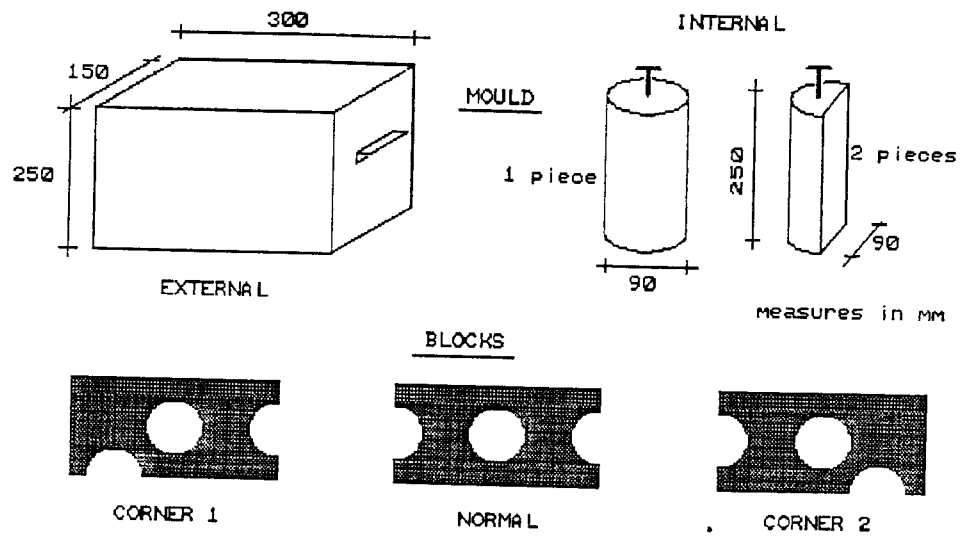

Figure 4: Rectangular block. Hole-pieces from piping

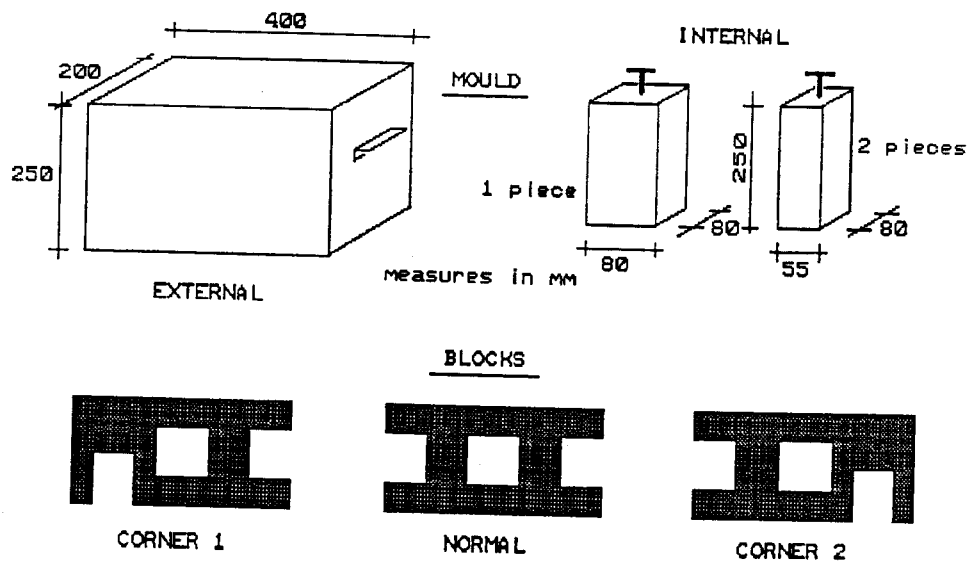

Figure 5: Rectangular block. Hole-pieces from rectangular moulds

2.4 The Cover

If the tank is intended to hold drinking water, the cover is an important part.

Atmospheric dust, debris, insects, microscopic algae, rodents, birds, etc can get easy access to the water if a cover is absent. Thus the cover will make a barrier against contamination.

The most popular covers include:

- thin concrete slab
- ferro–cement slab
- asbestos plate
- iron or tin plate
- plastic plate
- flexible plastic covers
- hardened mud/straw
- wooden boards
- canes/sticks/branches

As materials and ways of making a cover are so numerous, and as most of the techniques of making them are easy, no description is going to be presented here.

The choice for a cover will depend primarily on local materials and local worker skills.

Nevertheless, independent of the type of cover, two important features should be noted:

- Will not present holes, cracks or any possibility of connections between the outside and the inside.
- Will be easily removable or have a manhole to permit the access to the tank for cleaning purposes.

3. CONSTRUCTION TECHNIQUES

3.1 The Slab

Clean the ground of big stones, grass, bushes, etc. Make a square or rectangular frame with boards.

The length of the boards should be such that the slab presents 10–20 cm free space over the diameter or the sides of the tank walls (e.g. if the tank external diameter is going to be 1.90 m, then the slab should have a length of 2.10 – 2.30 m. If a rectangular tank is going to be 1.60 x 1.80 m – external measures – then the slab should be 1.80 x 2.00 m or 2.00 x 2.20 m).

Total measures for the boards are:

Length	20–40 cm longer than external tank sides or diameter
Width	15 cm
Thickness	1 cm

Place the frame on the ground, and with the aid of a level, level the four sides. This is to ensure that the platform is going to be horizontal.

Ideally the slab should be iron-reinforced, so make a grid with:

Reinforcing rod	8 mm diameter
Separation between parallel rods	10 cm
Separation between the external rod and the wood frame	5 cm
Length of the rods	wood frame length minus 10 cm

To calculate the length of the reinforcing rod, you need –firstly to calculate the number of parallel rods on each direction.

To do this, consider that if one side is Y meters long, you will need $Y \times 10$ rods.

Example:

One rectangular slab is intended to be 2.30 m x 1.80 m. How many rods and what total rod length will be needed?

Side 1: 2.30 m

Number of rods: $2.30 \times 10 = 23$ rods

Length of each rod: $1.80 \text{ m} - 0.1 \text{ m} = 1.70 \text{ m}$

Total length of rods for side 1 = $23 \text{ r} \times 1.70 \text{ m} = 39.1 \text{ m}$

Side 2: 1.80 m

Number of rods: $1.80 \times 10 = 18$ rods

Length of each rod: $2.30 \text{ m} - 0.1 \text{ m} = 2.20 \text{ m}$

Total length of rods for side 2 = $18 \text{ r} \times 2.20 \text{ m} = 39.6 \text{ m}$

Total length of rods for the grid = $39.1 \text{ m} + 39.6 \text{ m} = 78.7 \text{ m}$

Approx 80 m

Remember that the rods can be cut and tied, so for this example if the reinforcing rods are sold in pieces of 6 m, you will need 14 pieces ($6 \text{ m} \times 14 = 84 \text{ m}$)

If the reinforcing rods are sold in 12 m pieces, you will need 7 pieces ($12 \text{ m} \times 7 = 84 \text{ m}$).

Fig. 6 shows how the grid should be placed inside the frame, in the case of the given example.

The rods are tied with wire at the crossings.

Once the grid is ready, place it on the ground inside the frame. The concrete will be poured on top of it for maximal structural strength.

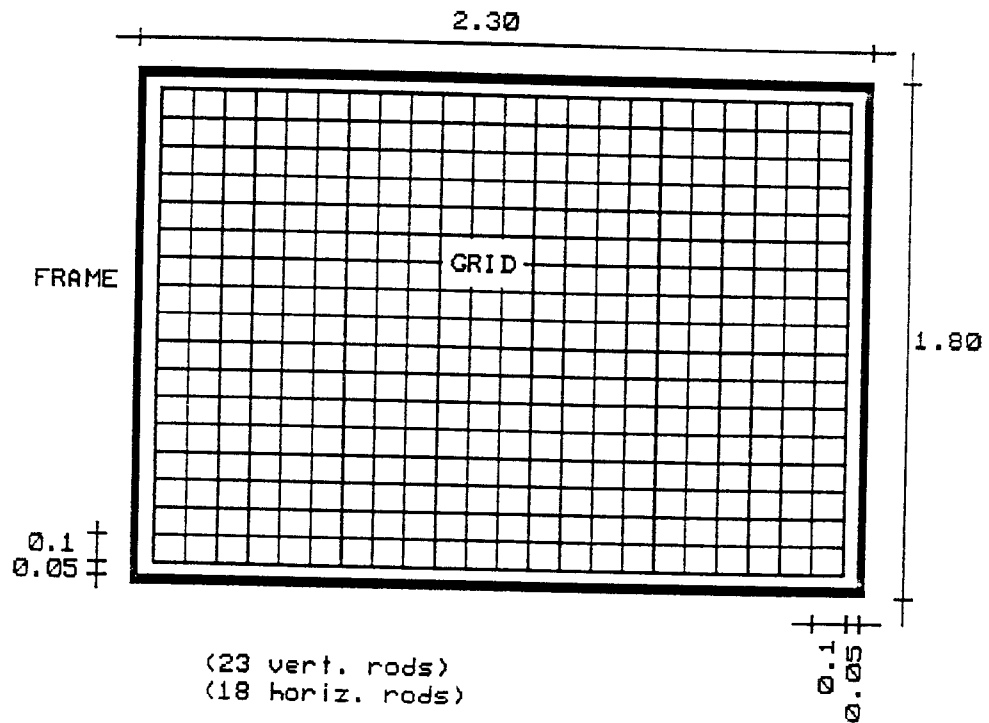

Figure 6: Grid inside the slab frame

Make the concrete mixture.

This mixture will have the following proportion (in volume).

Cement	1 part
Sand	2 parts
Gravel/small stones	3 parts

To know the quantities of the different materials, make a calculation to know the volume of mixture you will need to fill the frame.

$$\text{Vol mixture} = \text{length (m)} \times \text{width (m)} \times \text{height (0.15 m)}$$

The relative quantities of cement, sand and gravel to make 1 m³ of mixture are:

Cement	300 kg
Sand	0.5 m ³
Gravel	0.75 m ³

Example

Find out the quantities of cement, sand and gravel to fill the frame of the previous example.

$$\text{Vol} = 2.30 \text{ m} \times 1.80 \text{ m} \times 0.15 \text{ m} = 0.621 \text{ m}^3$$

$$\text{Now for cement: } \frac{0.621 \text{ m}^3 \times 300 \text{ kg}}{1 \text{ m}^3} = 186 \text{ kg}$$

$$\text{For sand: } \frac{0.621 \text{ m}^3 \times 0.5 \text{ m}^3}{1 \text{ m}^3} = 0.3 \text{ m}^3$$

$$\text{For gravel: } \frac{0.671 \text{ m}^3 \times 0.75 \text{ m}^3}{1 \text{ m}^3} = 0.46 \text{ m}^3$$

Once the mixture is ready, pour it inside the frame.

Smooth the surface with a trowel.

Allow the mortar to cure for at least 2 weeks. If the site of the slab is very sunny or if it is too hot, it is advisable to keep the surface wet by occasionally pouring water on top and/or by covering it with a plastic sheet. Any of these will help prevent the surface cracking. While the slab is curing, you can make the blocks.

3.2 The Blocks

To make the blocks, first choose an adequate place. This should be:

- As smooth as possible, with no grass, roots, stones, etc.
- Under the shade of a tree or building.

Now prepare the mortar.

Several mixtures can be used for this purpose.

People all around the world produce blocks using a cement:aggregate ratio ranging from 1:3 to 1:7. According to the experience gathered, this technical guide will suggest working with a

cement:aggregate ratio 1:5

A mortar with such a ratio makes use of a relatively small amount of cement (economic) but still it presents a considerably good structural strength.

As regards the type of aggregates, the two basic components are sand (the best sand is a mixture of fine and coarse sands), and gravel (no more than 10 mm in diameter).

The recommended mixtures are:

C : S : G

1 5

1 4 1

1 3 2

1 2 3

The tank builder should choose the mixture most suited to his needs, keeping in mind that coarse aggregate blends produce open-textured blocks while fine mixtures produce smooth, dense surfaces.

To make the mortar, good quality water should be added.

Some words with regard to water contents:

A fairly moist but crumbly mixture should be used. The mixture must be wet enough to bind together when compacted, but it should not be so wet that the blocks slump when the mould is removed. The moisture content should be as high as possible as this allows better compaction and thus gives the best strength, nevertheless practice will show the beginner that a block mortar is drier than a plastering one.

To know the amount of mortar and the quantities of cement and aggregates you will need for making the blocks, follow this procedure:

To make the exercise more complete, we will assume that you will use a mould of your own design.

To know how much material will be needed to make the blocks, three things should be determined:

- quantity (number) of blocks
- volume of mortar per block
- volume of different mortar components per volume unit

To determine the quantity of blocks, calculate as follows:

First you should know what volume your tank will hold and what height will it be (remember that the maximum height is 2 m).

Then:

$$\text{Surface} = \frac{\text{Volume}}{\text{Height}}$$

The blocks should be placed forming the perimeter of this surface.

So knowing the length of each block, you can find how many blocks you will need for each row.

If you are using straight blocks, please note that at every corner there is an overlap. (See Fig 7 for example).

The number of rows is:

$$\text{Number of rows} = \frac{\text{Tank height}}{\text{Block height}}$$

The final number of blocks is:

$$\text{No of blocks} = \text{No of rows} \times \text{blocks in a row}$$

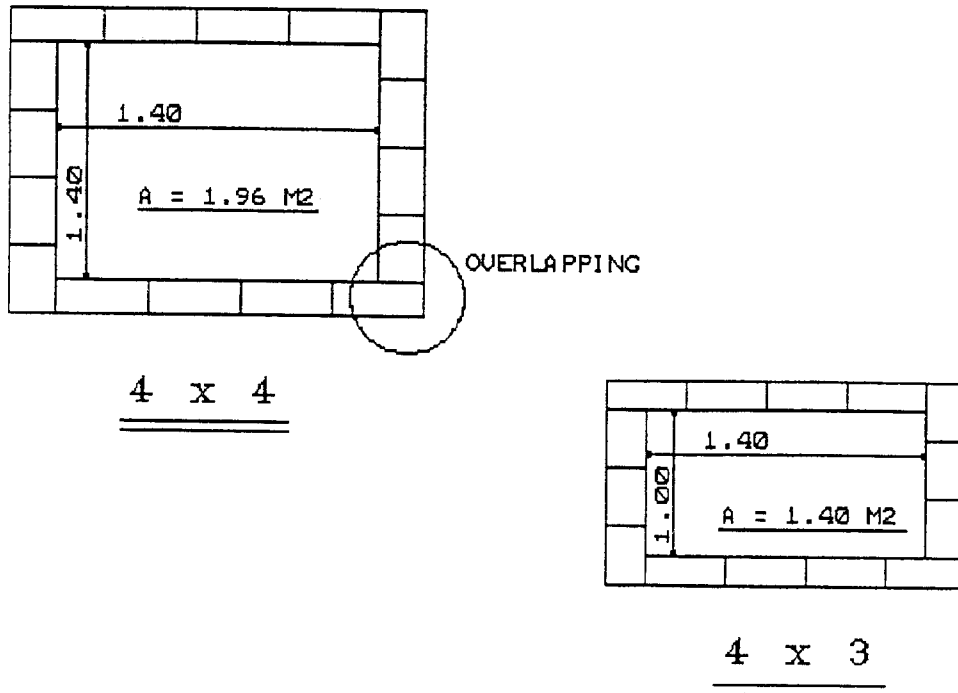

Figure 7: Blocks array. Overlapping consideration

Example

Let us build a tank of approximately 2.40 m^3 , using rectangular blocks of size $0.40 \text{ m} \times 0.20 \text{ m} \times 0.20 \text{ m}$ ($L \times W \times h$). The height of the tank should be 1.80 m . How many blocks will be needed?

First find out the surface of the tank floor:

$$\text{Surface} = \frac{2.40 \text{ m}^3}{1.80 \text{ m}} = 1.33 \text{ m}^2$$

Now find the perimeter. The most practical way to do so, is by using a “trial and error” method. With your blocks, if you make an array of 4×4 blocks, you will see that the internal size of the tank floor will be $1.40 \text{ m} \times 1.40 \text{ m}$ or 1.96 m^2 . (Take care with overlapping! Please have another look at Fig. 7). Now, if you make an array 4×3 blocks, the internal size of the tank floor will be $1.40 \text{ m} \times 1.00 \text{ m}$, or 1.40 m^2 . That is pretty close to our 1.33 m^2 . In that array, it will need 14 blocks.

The number of rows are the tank height divided by the block-height.

$$\text{No of rows} = \frac{1.80 \text{ m}}{0.2 \text{ m}} = 9$$

$$\text{No of blocks} = 14 \frac{\text{blocks}}{\text{row}} \times 9 \text{ rows} = 126 \text{ blocks}$$

To know the volume of mortar per block, first you will have to find out the effective mortar volume (emv).

The emv is the volume the mortar will fill in the block, excluding the volume of the holes, so:

$$\text{emv} = \text{block volume} - \text{holes volume}$$

But this is not the mortar volume, because as it will be seen while producing a block, the mould with mortar will be shaken to produce compactation. If there is a mortar compactation, then, obviously the real quantity of mortar to be used will be larger than the emv. If the compactation is carried out in the way suggested in this guide, then a reduction in the mortar volume of about 20% can be expected.

So the effective volume of mortar to be used per block will be:

$$\text{Volume of mortar per block} = \text{emv} \times 1.2$$

Example

What is the volume of mortar per block, if the block of this example has 3 holes as shown in Fig. 8?

The two side holes are two semicylinders of same diameter. In fact it can be said that it is one cylinder split in two and we will call it the “sides cylinder”.

MOULDS

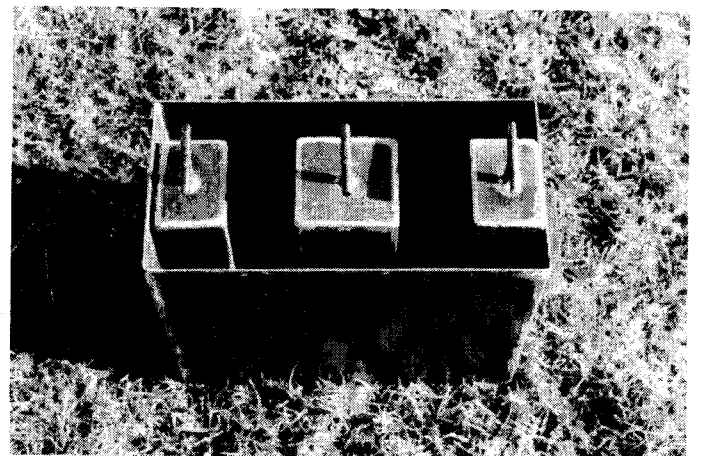
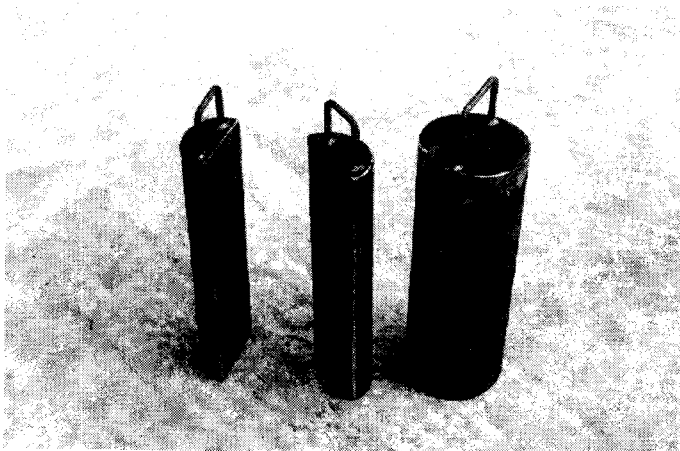
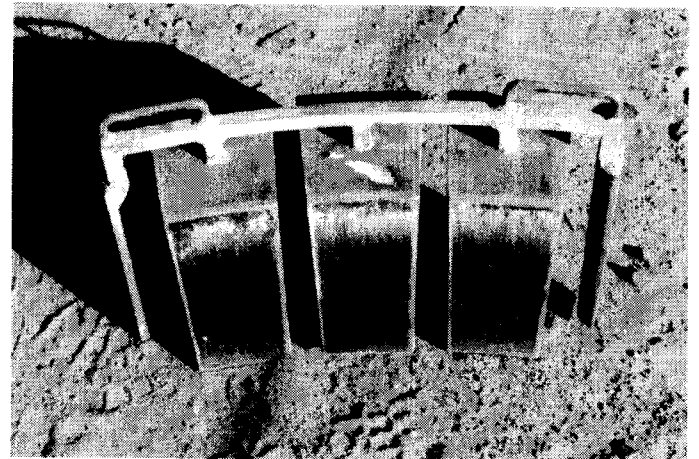
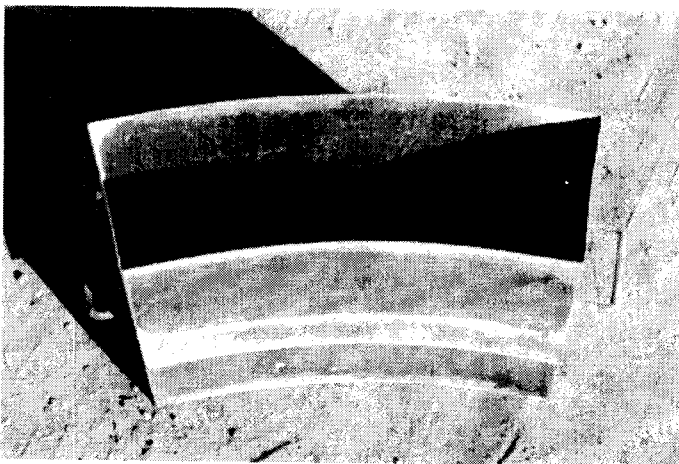
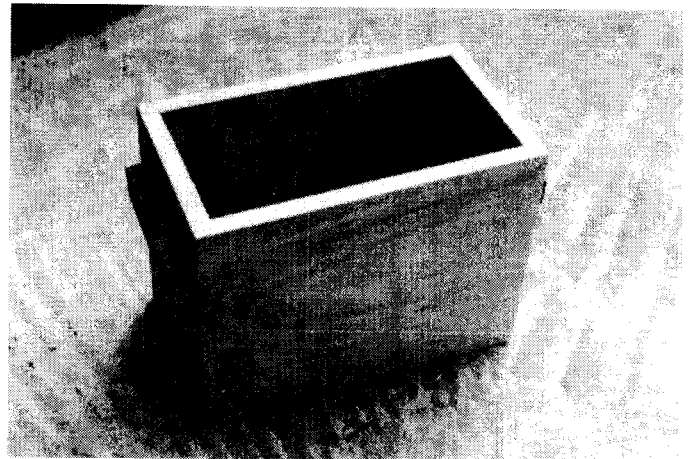
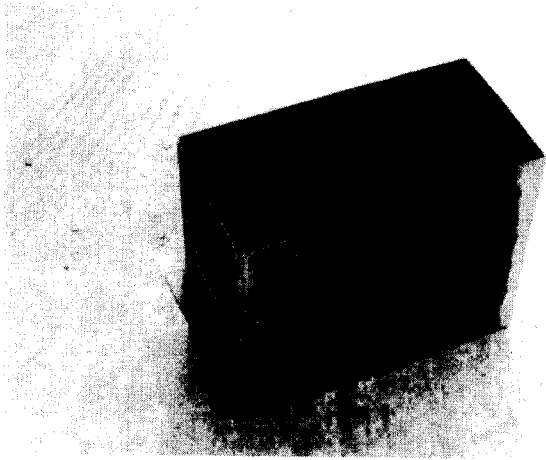

Different types of moulds

BLOCKS

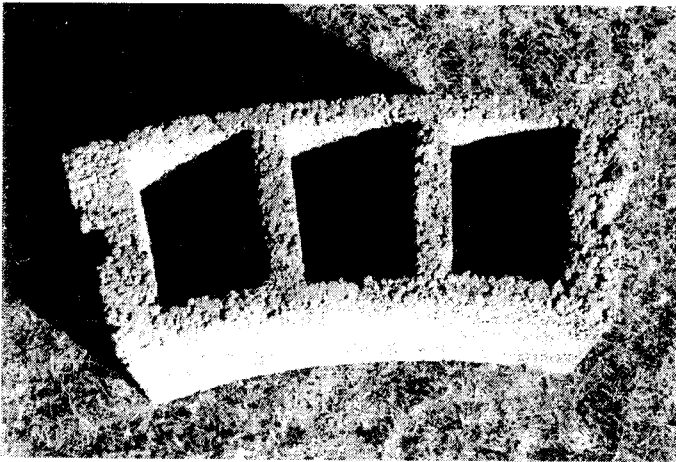

Curved blocks

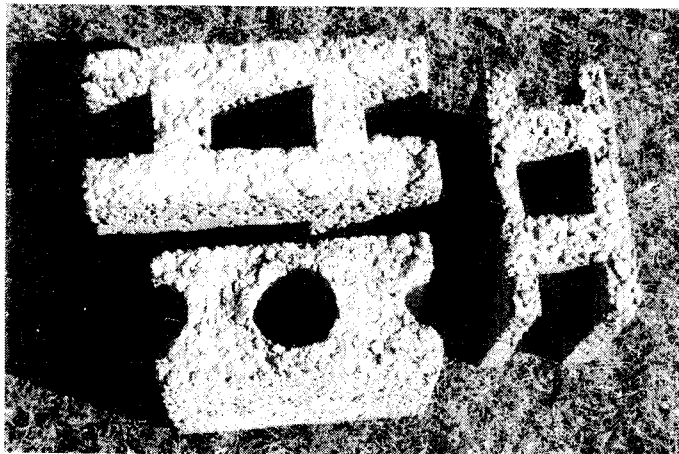
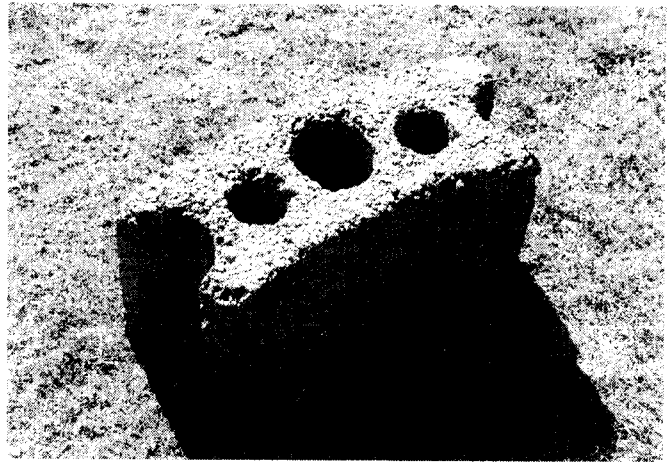

Rectangular blocks



Left and right cornered blocks

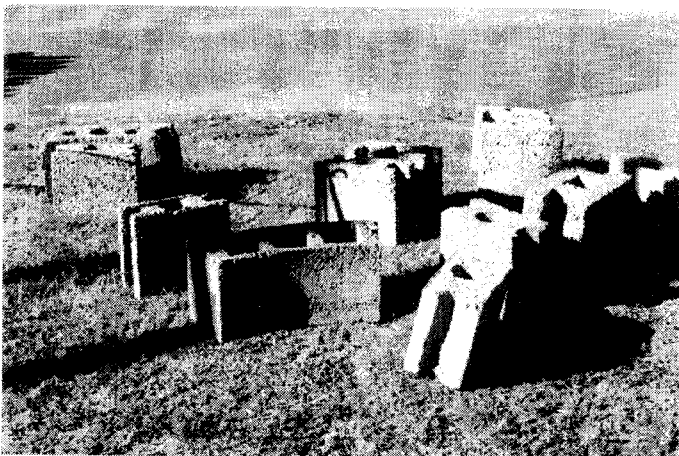

Different types of blocks



Block production for a tank

BLOCK PRODUCTION



Placing internal moulds

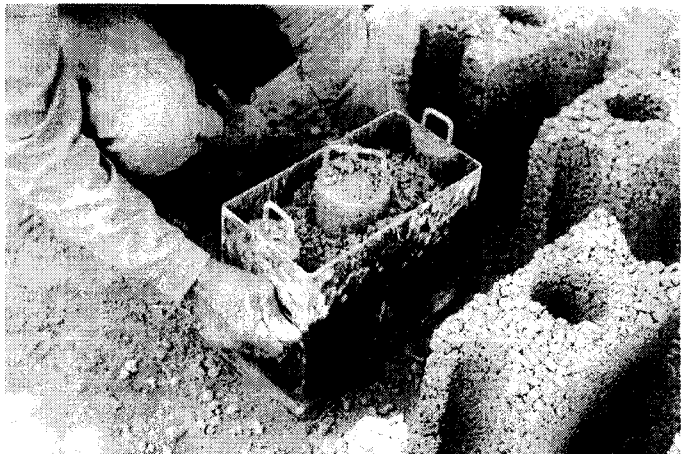

Compacting

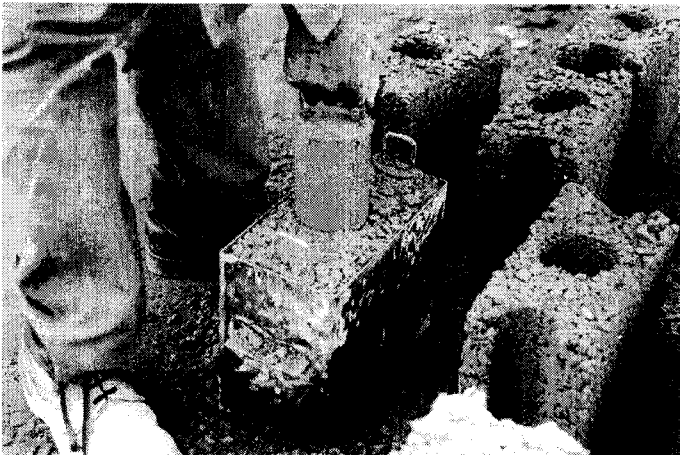

Lifting internal moulds



Lifting external mould



Curved block production

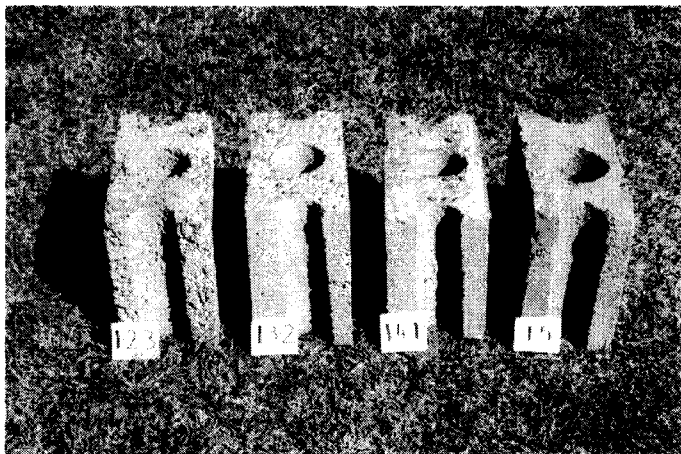

Blocks with different C:S:G ratio

SLAB

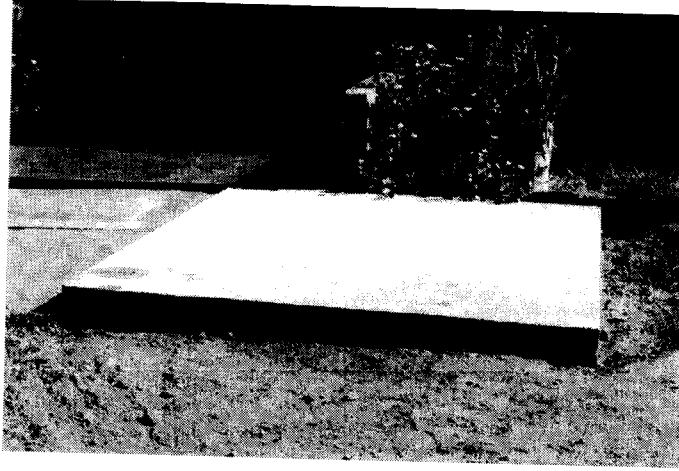

CONSTRUCTION SEQUENCE

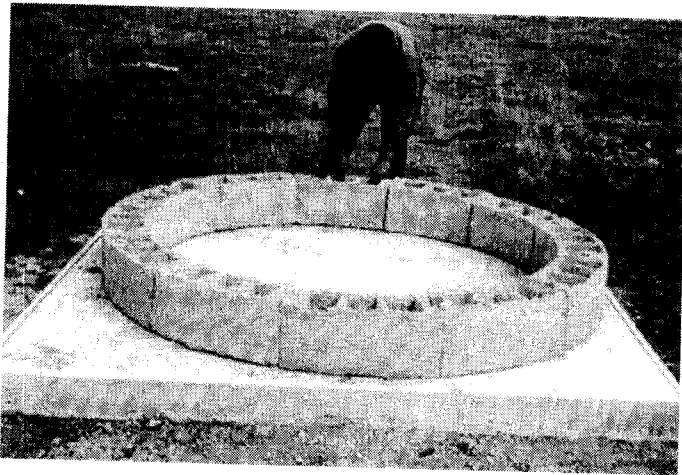

Laying the first row

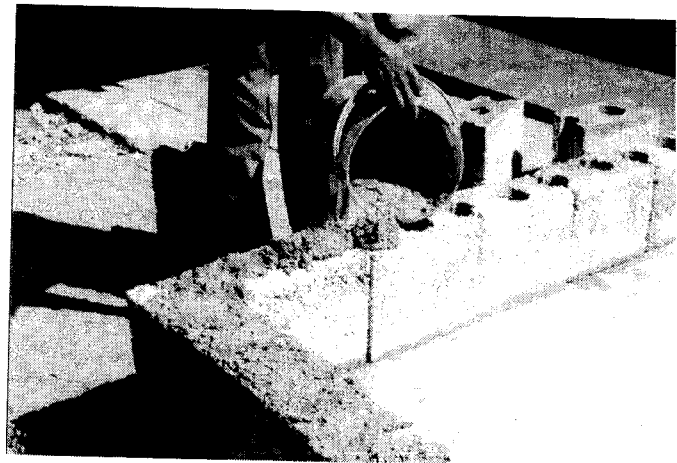
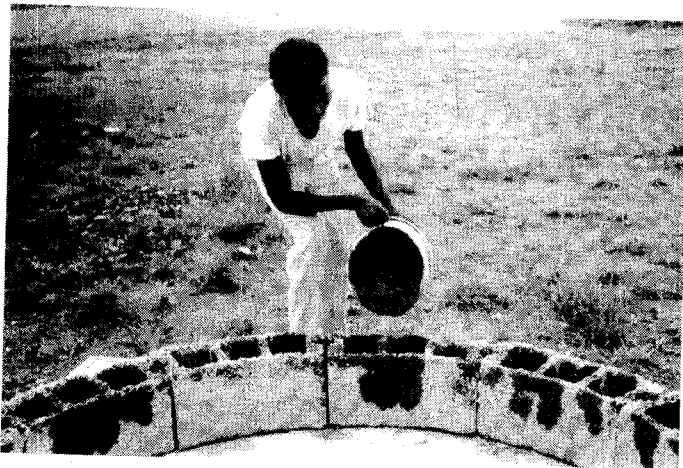

Filling holes in the first row

CONSTRUCTION SEQUENCE (Continued)



TANKS READY FOR PLASTERING

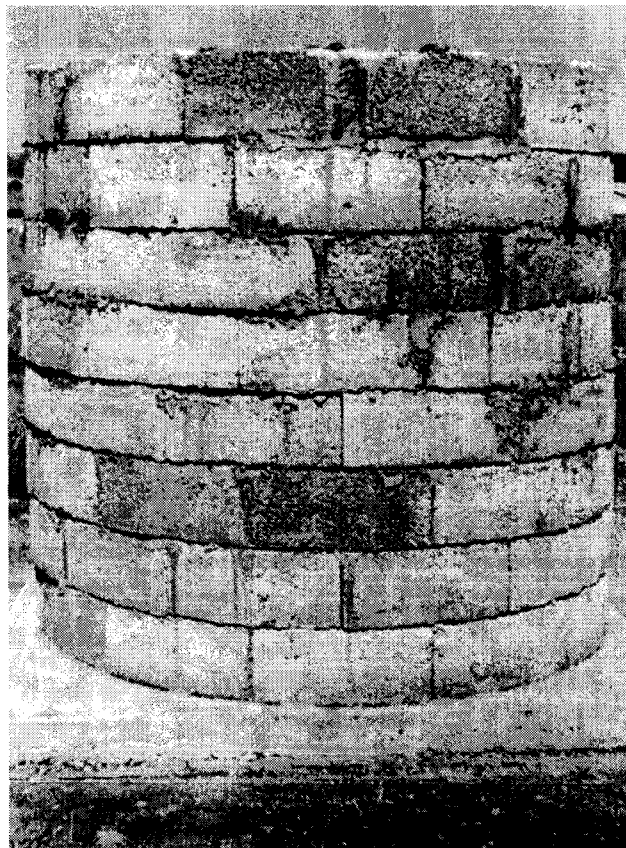
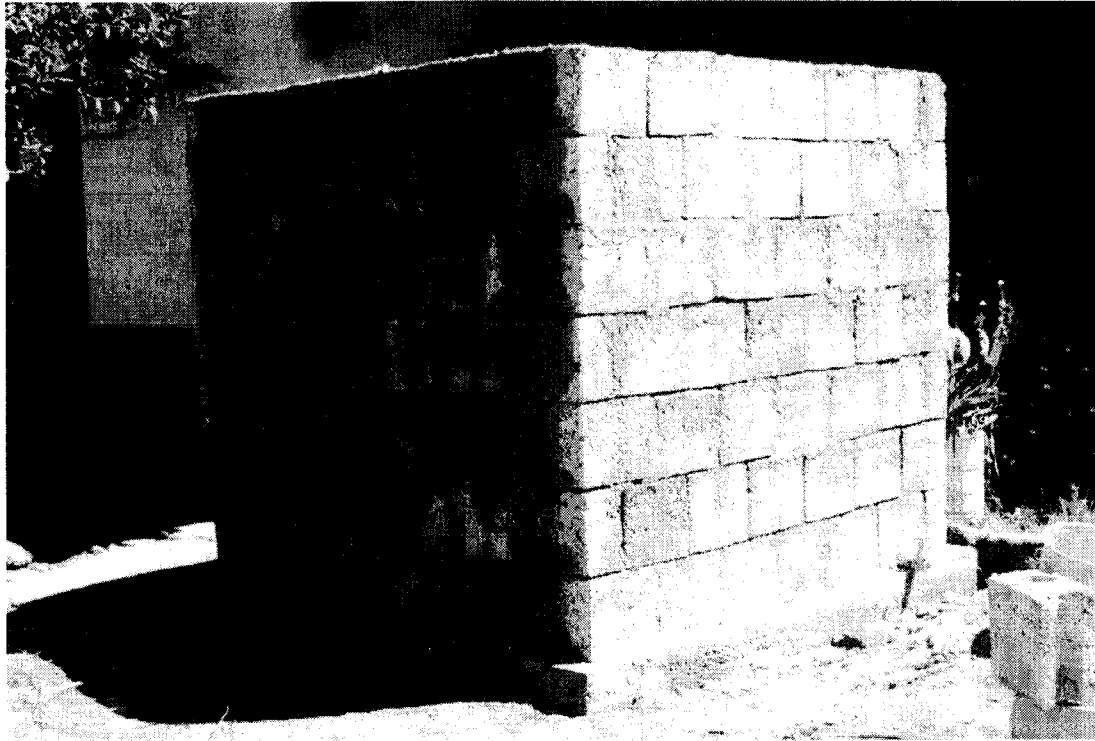



Tap



Drain

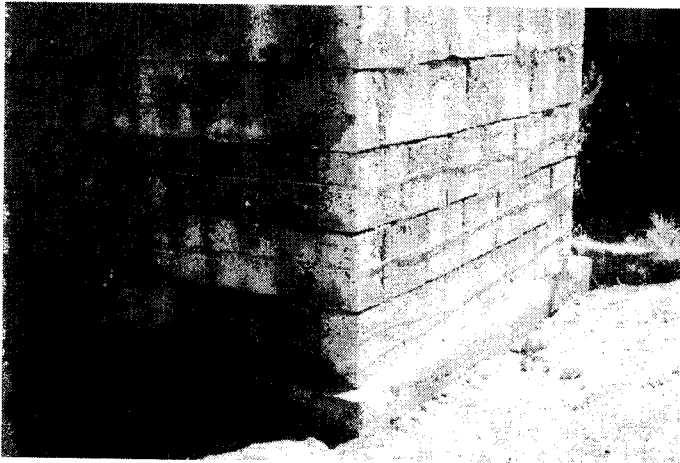

Reinforcing

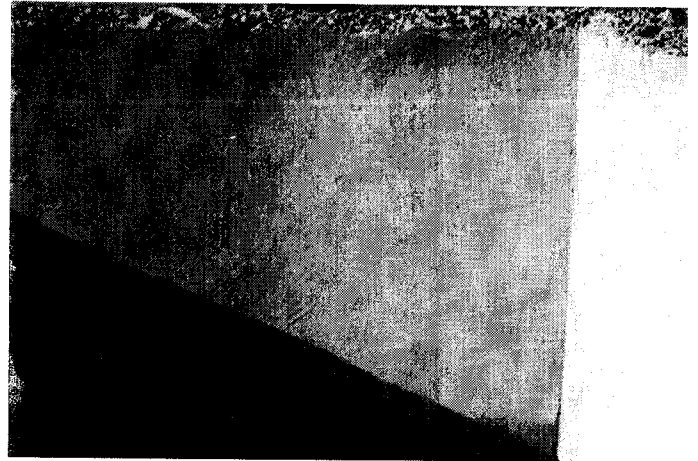

Inside plastering



Outside plastering

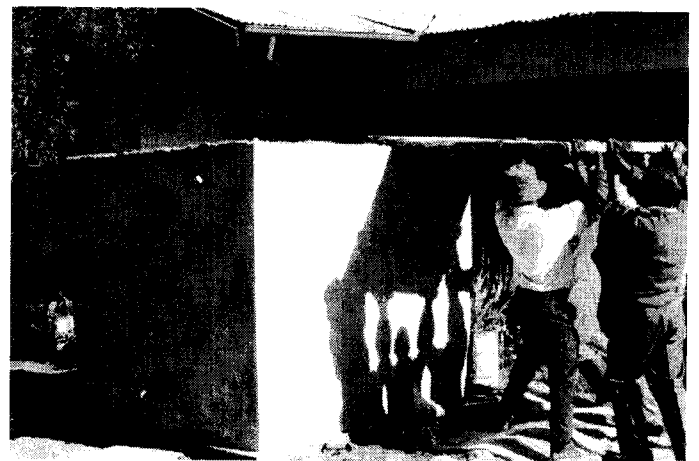

Cover

THE WATER TANK

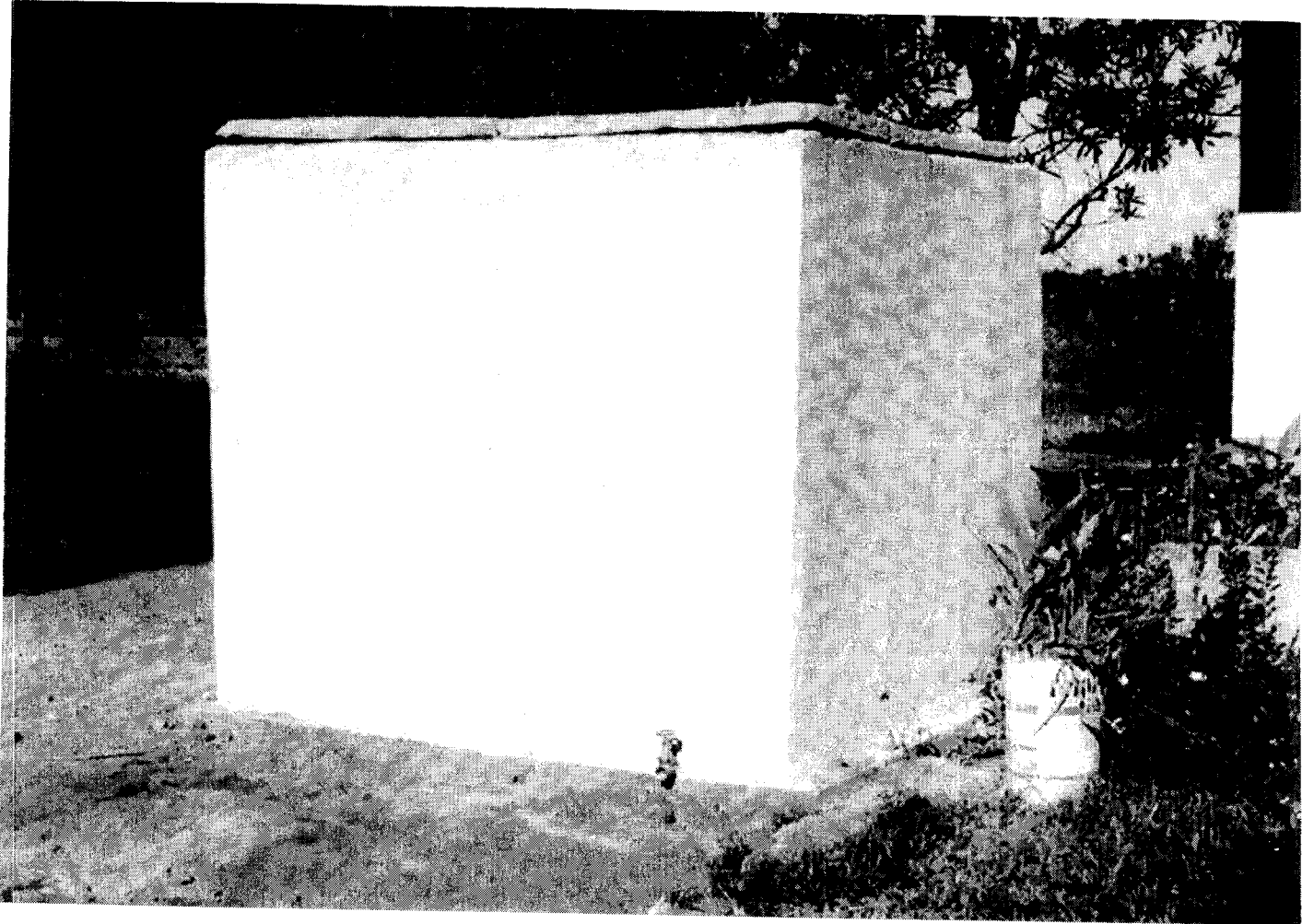

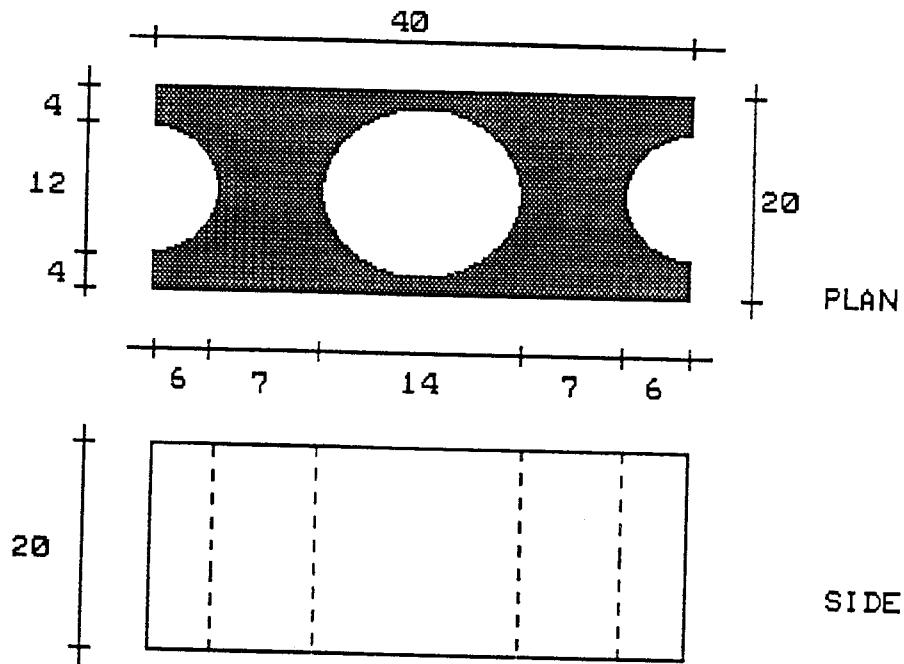

Figure 8: Block used for exercise

The volume of the “sides cylinder” is:

$$3.14 \times \text{radius} \times \text{radius} \times \text{height} =$$

$$3.14 \times (0.06 \times 0.06) \times 0.2 = 0.0023 \text{ m}^3$$

The volume of the central cylinder is:

$$3.14 \times 0.07 \times 0.07 \times 0.2 = 0.0030 \text{ m}^3$$

The volume of the holes will be:

$$0.0023 \text{ m}^3 + 0.0030 \text{ m}^3 = 0.0053 \text{ m}^3$$

This should be deduced from the block volume.

The block volume is:

$$L \times W \times h = 0.4 \text{ m} \times 0.2 \text{ m} \times 0.2 \text{ m} = 0.0160 \text{ m}^3$$

So the effective mortar volume will be:

$$\text{emv} = 0.0160 \text{ m}^3 - 0.0053 \text{ m}^3 = 0.0107 \text{ m}^3$$

The mortar we will need is going to be a 20% larger, as a considerable compaction will occur. So:

$$\text{Volume of mortar per block} = 0.0107 \times 1.2 = 0.0128 \text{ m}^3$$

(In practical terms this is 12.8 litres but as we are referring to all our measures in meters, it is advisable to continue using that way of expression).

At this stage, the total amount of mortar that is going to be needed to make the blocks can be determined.

$$\text{Total mortar for blocks} = \text{Vol of mortar per block} \times \text{No of blocks}$$

For our example:

Total mortar for blocks =

$$0.0128 \frac{\text{m}^3}{\text{block}} \times 126 \text{ blocks} = 1.61 \text{ m}^3$$

As we want to know how much cement, sand and gravel we should buy or get, we arrive at the last calculation to obtain the volume of different mortar components per volume unit.

The following table is presented with the relative weights and volumes for the different mixtures.

The quantities of cement, sand and gravel are sufficient to make 1 m³ of mortar.

Mixture Ratio	Quantities for 1 m³ mortar		
	C(kg)	S(m3)	G(m3)
C : S : G			
1 5	300	1.25	
1 4 1	300	1.0	0.25
1 3 2	300	0.75	0.5
1 2 3	300	0.5	0.75

If we choose a mixture C:S:G = 1:3:2, then the quantities of the components to be used are for our example.

$$\text{Cement} = \frac{1.61 \text{ m}^3 \times 300 \text{ kg}}{1 \text{ m}^3} = 483 \text{ kg}$$

$$\text{Sand} = \frac{1.61 \text{ m}^3 \times 0.75 \text{ m}^3}{1 \text{ m}^3} = 1.21 \text{ m}^3$$

$$\text{Gravel} = \frac{1.61 \text{ m}^3 \times 0.5 \text{ m}^3}{1 \text{ m}^3} = 0.80 \text{ m}^3$$

At this stage all that should be known is known: number of blocks, amount of mortar and the relative quantities of the different mortar components.

Next comes the block production.

This is very simple and should be made following the technique step by step.

- Put the mould on a clean and even floor.
- Put the hole-producing pieces in place.
- Fill the free spaces in the mould with mixture.
- Shake the mould (taking hold of handles) for about 30 seconds.
- Add more mixture to the free spaces in the mould.
- Shake for another 30 seconds.
- Make sure the upper surface is even.
- Take out the hole-producing pieces by lifting with the handles.
- Lift external mould carefully.

While making blocks, it is important to consider the “type” of block. What does it mean?

If using a curved mould to make curved blocks, there is going to be only one type of block, as all these elements in the tank structure are going to be exactly the same.

But if making rectangular blocks, then there will be two types of blocks: the "normal" ones and the "corner" ones.

As the block design is such that the holes will be the linking structure when filled with slurry, it is important that all side holes should be matching.

If we look at Fig. 9 we will see how the blocks in a row should correlate with their holes.

And at this point the different patterns already shown in Figs 4 and 5, should be remembered.

A corner block is made just by placing the hole producing pieces in a convenient way.

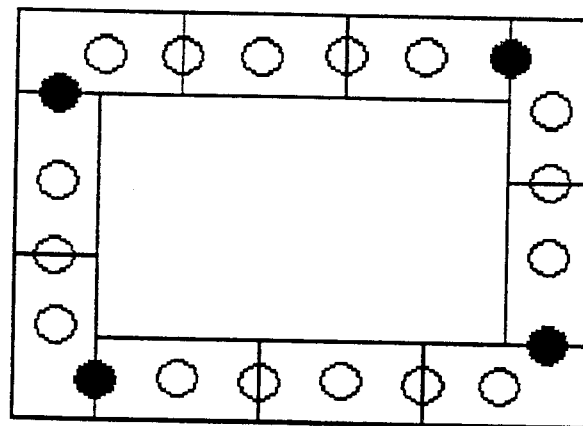

LEFT CORNERED
BLOCKS

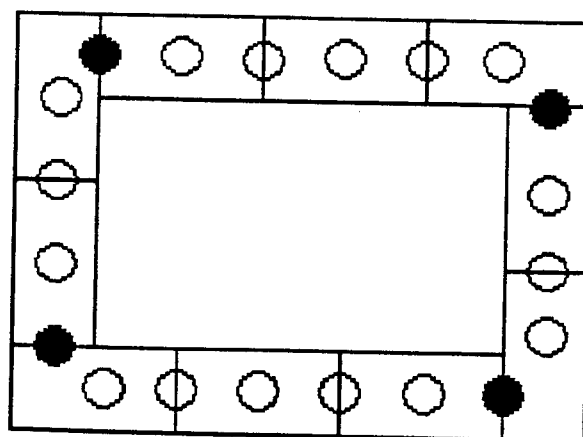

RIGHT CORNERED
BLOCKS

Figure 9: Corner blocks

Depending on the sizes of these pieces, sometimes the central-piece should be displaced slightly to ensure that all internal walls in the block will never be thinner than 2.5 cm.

To know how many corner blocks your tank will need, here is the recipe:

Every row needs 4 corner blocks.

The corner blocks can be “right” or “left”.

And due to the need of cross-linking different rows, one row will have right cornered blocks and the next (upper one) left cornered blocks.

So to calculate the number of corner blocks, you need to find out the number of rows.

But let us go back to our example:

– *How many right and left cornered blocks will we need for our tank?*

As we had seen, the number of rows was 9.

5 rows will be right cornered blocks

4 rows will be left cornered blocks

So we will need:

$$5 \text{ rows} \times 4 \frac{\text{blocks}}{\text{row}} = 20 \text{ right c. blocks}$$

$$4 \text{ rows} \times 4 \frac{\text{blocks}}{\text{row}} = 16 \text{ left c. blocks}$$

The quantity of normal blocks is obviously the total number of blocks minus the corner blocks.

Once the blocks are ready, then allow them to cure for 4 – 5 days before using them.

In hot weather or if the blocks are placed under heavy direct-sun, it is important to spray them with water and cover with a plastic sheet to maintain a certain humidity level.

3.3 The Tank

Once the slab and the blocks are ready, it is time to start building the tank.

This is also very simple and the technique is as follows:

- Place the first row of blocks on the slab, following the array previously chosen for a certain perimeter.
- Be sure that the blocks are placed tightly next to each other.
- Once the first row is ready, prepare a wet mixture of:

Cement	1 part
Sand	3 parts

To make 1 m³ of mortar, cement/sand ratio 1:3, will be needed

Cement	500 kg
Sand	1 m ³

- Pour this mortar in the block holes.
- Place a second and a third row each on top of the previous. The blocks in adjoining rows should be cross linked (i.e. the side-end of one block should correspond with the centres of the blocks in the upper and lower rows).
- Pour a slurry of soil-cement or sand-cement through the holes of the upper row.
- The slurry should be conveniently flowing to fill all the empty spaces, but consistent enough not to escape through the very tiny interspaces.

The ratio cement:soil or cement:sand is:

Cement	1 part
Sand or soil	10 parts

To make 1 m³ of slurry with this c:s ratio, mix:

Cement	150 kg
Sand or soil	1 m ³

- Place two more rows of blocks and pour soil cement.
- Continue this way until reaching the desired height.

Example

Calculate the amount of slurry 1:10 to be used while building the tank of our example.

If we remember, in a previous exercise we found out the volume of the holes in one block. This was:

$$\text{Volume of holes per block} = 0.0053 \text{ m}^3$$

We had 9 rows, but the first one was filled with a “thick” (1:3) mixture. In the number of rows to be considered for the calculation we have:

8 rows

As it was found the number of blocks per row was 14, so the number of blocks will be:

$$14 \frac{\text{blocks}}{\text{row}} \times 8 \text{ rows} = 112 \text{ blocks}$$

The volume of slurry is:

$$\text{Volume of holes per block} \times \text{No of blocks}$$

So:

$$\text{Volume of slurry} = 0.0053 \frac{\text{m}^3}{\text{block}} \times 112 \text{ blocks} = 0.59 \text{ m}^3$$

The quantities of the components to be used are:

$$\text{Cement} = \frac{0.59 \text{ m}^3 \times 150 \text{ kg}}{1 \text{ m}^3} = 88 \text{ kg}$$

$$\text{Sand or soil} = \frac{0.59 \text{ m}^3 \times 1 \text{ m}^3}{1 \text{ m}^3} = 0.59 \text{ m}^3$$

The tank will be well structured through the slurry-through-holes system. If the height is 2 m or less, then the tank will be stable and strong.

Nevertheless, considering the pressure the mass of water exerts on the walls, and considering also that some weakness may develop in the structure due to defective blocks, not homogeneous filling of the holes, etc. it is then advisable to bring on structural reinforcing.

This can be done by means of 3 or 4 rings of mild steel rods or strips embracing the wall.

As the structural efforts are stronger at the bottom these rings should be placed favouring the lower part of the tank. See Fig 10.

The rings will be hidden in the outside plastering.

The tank built in accordance with these instructions should be quite homogeneous, with no cracks or holes in its walls. But it is possible that small fissures and even the natural porosity of the blocks may allow the passage of water from the inside to the exterior.

For this reason it is necessary to plaster the inside walls and the slab surface.

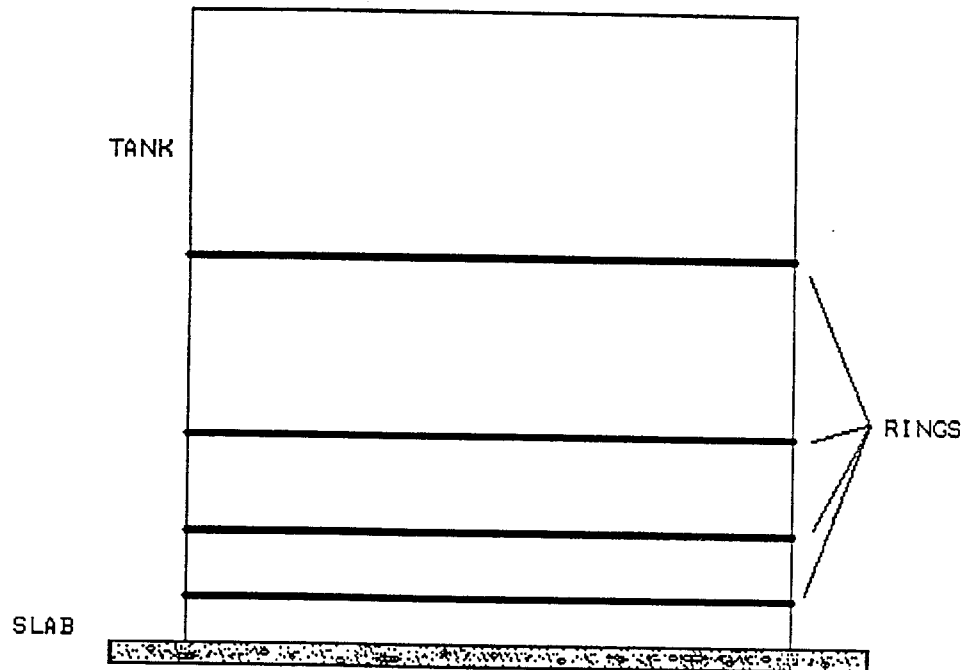

Figure 10: Reinforcing rings

The mortar for plastering should have the proportion:

Cement	1 part
Sand	3 parts

The thickness of the plaster layer should be approximately 1.5 cm.

Example

Continuing with our example, let us find the quantities of cement and sand to be used in the internal plastering of the tank.

As it has been calculated, the internal sides of the walls measure 1.40 m x 1.00 m.

Thus the perimeter is:

$$1.40 \text{ m} + 1.00 \text{ m} + 1.40 \text{ m} + 1.00 \text{ m} = 4.8 \text{ m}$$

The wall surface to be covered is:

Wall surface = perimeter x height or

$$\text{Area} = 4.80 \text{ m} \times 1.80 \text{ m} = 8.64 \text{ m}^2$$

It was said that the plastering thickness should be 1.5 cm.

So the plastering volume will be:

$$V = \text{Area} \times 0.015 \text{ m}$$

$$V = 8.64 \text{ m}^2 \times 0.015 \text{ m} = 0.13 \text{ m}^3$$

Plastering the floor surface (the slab) will require:

$$V = \text{slab area} \times 0.015 \text{ m}$$

$$V = 1.40 \text{ m}^2 \times 0.015 \text{ m} = 0.02 \text{ m}^3$$

Total plastering mortar:

$$VT = 0.13 \text{ m}^3 + 0.02 \text{ m}^3 = 0.15 \text{ m}^3$$

The cement and sand quantities will be:

$$\text{Cement} = \frac{0.15 \text{ m}^3 \times 500 \text{ kg}}{1 \text{ m}^3} = 75 \text{ kg}$$

$$\text{Sand} = \frac{0.15 \text{ m}^3 \times 1 \text{ m}^3}{1 \text{ m}^3} = 0.15 \text{ m}^3$$

The plastering is important to achieve a good final product.

The mixture should be well prepared, with the right amount of water (ratio water/cement should be maintained at nearly 0.4 by weight as possible).

It is also advisable to use some additives to make the mortar as impermeable as possible. (A great number of these products are commercially available).

Ideally the plastering should be carried out in one day's work.

In the course of the normal plastering operation, the surface finishing job should be completed before the final set has occurred.

The surface should be smoothed to achieve the maximal waterproof property. This is done using wooden floats. On completion of wood floating, the surface should be steel trowelled to a very smooth surface finish.

Once this job is finished, the curing will take place. In order to obtain a good quality hardened mortar, the curing should take place in a suitable environment during the early stages of hardening.

Curing is the name given to procedures used for promoting the hydration of cement, and consists of a controlled temperature and of the moisture movement from and into the mortar.

More specifically, the object of curing is to keep the mortar saturated in order that certain products of the cement can be hydrated. Hydration cannot take place without water and if the mixing water is allowed to dry out of the mortar, hydration and consequently, the strength development and durability will be severely affected. Cracking, shrinkage or less strength development may occur.

Three ways of curing can be used in rural environment.

The first one is to carefully fill the tank with water on the day following the plastering and leave it there for 1–2 weeks. This water should be later discarded and not used for human purposes.

The second one is to keep the mortar in contact with a source of water for at least 7 – 10 days. This may be achieved by spraying or by covering the surface with a soaked cloth, straw, cotton mats, etc and keep them constantly wet.

The third one is to place an impermeable membrane or water-proof paper covering the finished surface. This cover will prevent evaporation of water from the mortar and water collected in the bottom will help to maintain the total humidity.

Outside plastering is not as vital as inside plastering, but it will give the tank a better looking finish. The mortar to be used is the same as the mortar used for the inside plastering, and the quantities of cement and sand can be obtained following the same reasoning process.

If the exterior surface is going to be painted, then a sponge should be used while finishing the plastering. This will provide a convenient roughness for subsequent painting.

Linked to the tank finishing activities comes the moment of placing a tap and a drain outlet. The tap will allow the user to get water from the tank.

The drain (nipple with valve) will allow the sediments and eventual dirt to be washed out.

Tap and nipple size $\frac{1}{2}$ " or $\frac{3}{4}$ "

Drain valve and nipple size 1"

These elements should be placed at different heights (from the floor and/or from the slab surface).

Both tap and drain are attached to a nipple connecting the tank exterior with the interior.

Tap 0.25 – 0.30 m (minimum to place a bucket below)

Drain 0.0 m (bottom level)

See Fig. 11.

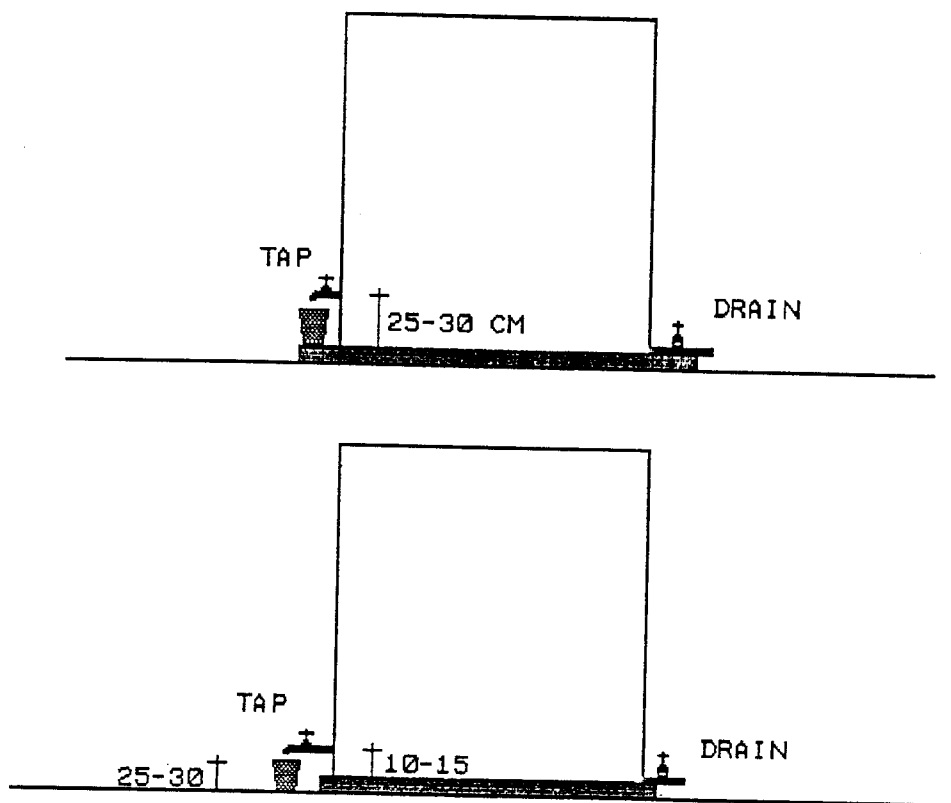

Figure 11: Tap and drain position

3.4 The Cover

As it was pointed out in point 2.4, a cover is an important barrier against contamination.

No tank intended for holding drinking water should be built and put into operation without having a cover.

In any case, the construction or provision of a convenient cover is easy to perform and, as there are so many possible ways of making it, the cover subject will not be discussed here.

4. TIME CONSIDERATIONS

The HFB Technique is relatively fast.

The most important time-factor to consider while building a tank, is related to the preparation of mortar.

In fact this is the bottle neck and total building time will depend upon the number and skills of the workers and with what tools they are equipped.

If the mortar is always available (which requires a competent two or three men team), then the following times can be expected for the different tasks (based on two workers and on a 5 m³ tank)

Slab	½ day
Block	1 every 3 minutes (or 130 – 160/working day)
Tank walls	½ day
Inside/outside plastering	1 day
Cover	½ day

5. TOOLS

When building a tank in an isolated rural environment, it is very important to have all the materials and tools that are going to be needed.

Mortar components can be calculated a-priori and should be in the place before the working team arrive or start to work.

Following, a list with materials and tools will aid in the logistics of the water tank production.

Materials

Cement

Sand

Gravel

Water repellent additive

Wood boards

Nails

Reinforcing rods

Wire

Tap/nipple

Drain (valve/nipple)

Material for the cover

Tools

Mould/s

Shovels

Wheel barrow

Trowels

Wooden floats

Steel trowels

Level

Hammer

Saw

Buckets

Hacksaw

Pliers

Ladder (useful but not indispensable)

6. INTO OPERATION

After the tank has been built, the mortar (blocks, slurry, etc) cured and the cover in place, the moment has arrived to start to use it.

Nevertheless, it is advisable that before we fill it with water intended for drinking purposes, a thorough disinfection is provided.

Along the construction process, dirt, debris and human direct-contact have, without doubt, contaminated the tank interior.

This contamination is going to be transferred to the stored water, and hence the need for disinfection.

To disinfect the tank, the best way to do it is:

- Clean the interior from debris, dust, stones, etc.
- With a cloth soaked in sodium hypochlorite (Javel/Jik –without perfume), rub the walls and the floor. (Use gloves to protect the hands).
- Fill the tank with water.
- Add 1 litre of sodium hypochlorite for every 1 m³ of tank capacity.
(A 4.7 m³ tank will need approximately 5 litres of disinfecting solution).
- Let the water with the sodium hypochlorite stand for 24 hours.
- Discard the water using both the tap and the drain.

Now the tank is ready for use.

7. MAINTENANCE

A water tank maintenance is simple and should be carried out in order to prolong the tank life.

Two aspects should be considered in maintaining a tank.

First, the structural one.

Cracks and leakages should be fixed as soon as they are detected. Failing to do so will eventually aggravate the problem, will transform the surroundings into a muddy place and lower hygiene and presentation.

The second aspect is hygiene.

For hygienic and health purposes, the tank interior should be clean and uncontaminated.

Cleaning and disinfection, as described in the previous point, should be carried out periodically.

The frequency of such activities depend very much on the type of water to be stored.

If the water is clean, without turbidity and without bacterial contamination, then a preventive maintenance operation should be practiced once a year.

If the water has any of the above mentioned problems, then the frequency should be higher.

Important advice is that if usually contaminated water is being stored, then disinfection should be carried out inside the tank on a continuous basis. (There are several systems to disinfect water in a tank).

An alternative to this is to use the water from the tank but do disinfect it before using for cooking or drinking. (e.g. disinfection through ebullition).

Hygiene in the surroundings of the tank is also important to prevent mud and the presence of insects.

8. SUMMARY OF RELEVANT INFORMATION

SLAB

Frame

Length: 20 – 40 cm longer than external tank sides or diameter

Width 15 cm

Grid

Diameter reinforcing rods 8 mm

Separation between parallel rods 10 cm

Separation between the external rod and wood frame 5 cm

Length of rods : wood frame length minus 10 cm

No of rods per side = 10 x side length in m

Concrete

Ratio C – S – G = 1:2:3

Quantities for 1 m³ concrete

C 300 kg

S 0.5 m³

G 0.75 m³

BLOCKS

Ratio cement/aggregate = 1:5

Recommended mixtures and quantities for 1 m³

C : S : G	C(kg)	S(m ³)	G(m ³)
1 5	300	1.25	
1 4 1	300	1.0	0.25
1 3 2	300	0.75	0.5
1 2 3	300	0.5	0.75

Mortar needed per block:

emv = block volume – holes volume

Volume of mortar/block = emv x 1.2

TANK

$$\text{Surface} = \frac{\text{Volume}}{\text{Height}}$$

$$\text{No of rows} = \frac{\text{Height}}{\text{Block height}}$$

No of blocks = No of rows x blocks in a row

If making a square or rectangular tank there will be:

4 corner blocks per row

SLURRY

Ratio cement : sand/soil 1:10

Quantities for 1 m³ mixture

Cement 150 kg

Sand/soil 1 m³

PLASTERING

Ratio cement : sand 1:3

Quantities for 1 m³ mixture

Cement 500 kg

Sand 1 m³