

SAFETY IN MINES RESEARCH ADVISORY COMMITTEE

FINAL REPORT

**Development and evaluation of a new
prototype P&T system to determine
in-heading gas release rate**

F J van Zyl

Research Agency : CSIR Miningtek
Project No. : COL 622 (EC01-0629)
Date : November 2001

Executive Summary

In order to quantify the potential methane hazard in underground coal mines, it is necessary to determine the in-seam methane content and an expected gas release rate during production. Various methods for estimating this have been proposed, ranging from empirical formulae to direct measurement of the methane released from coal samples in the form of drill chippings or cores. These methods generally suffer similar drawbacks, i.e. they are site-specific, have long time delays before data become available, use small sample sizes and/or inaccurate estimation methods, often involve cumbersome test and post-test procedures, etc. Despite their shortcomings, these are the only methods currently available to the industry. It was decided to investigate alternative methods that would be inexpensive, easy to use by mine personnel, robust enough for use in a production section, and provide information in as short a time as possible. To overcome the above drawbacks, a new approach was explored that would eliminate as far as possible the current drawbacks.

Initial investigations were focused on a theoretical gas release rate model which postulates that five parameters govern the rate of gas release from cut coal. The model was modified to simulate pressure build-up due to gas release into a hermetically sealed environment. The test was performed physically by sealing a cut coal sample in a canister and measuring the pressure build-up due to gas release. The theoretical model's pressure vs time pressure curve was then 'adjusted' by varying the identified governing parameters to fit the measured curve. This will uniquely describe the parameters governing gas release, thus allowing the theoretical model to be used to calculate the gas release rate and content for the coal seam under ambient conditions. Although the actual and theoretical pressure curves were similar in shape, it proved very difficult to refine the gas release model sufficiently to give a unique set of governing parameters as convergence of the solution could not be found.

As the hardware for the experiment had already been built, it was decided to investigate the option of using the Ideal Gas Law to determine the rate of gas release from the cut coal for the first 30 minutes after it has been cut from the face. This will give a good indication of the gas generated during production at the face, which is a high-risk area with regard to the ignition of gas explosions.

The results obtained are encouraging. Due to the nature of the system, it gives accurate results, is easier to operate than current systems as it is semi-automated, has self-diagnostic abilities to increase confidence, and the quality of the data allows parameters to be developed that will give advance warning of increasing gas release levels. The system data can also be incorporated into current gas release rate databases or systems.

This report describes the process followed and the results obtained.

Table of contents

List of Tables	6
List of Figures.....	6
1 Introduction.....	7
2 Practical Methods for determining the Coal Seam Gas Content	7
3 Current South African Practice.....	9
4 New Theoretical Seam Gas Content Determination Concept.....	10
4.1 Objective	10
4.2 Theoretical Seam Gas Content Determination Concept.....	10
4.3 Theory Behind Desorption Model	11
4.4 Concept Data Acquisition System for Theoretical Model	16
4.4.1 Physical Parameters of Model-based P&T System	17
4.4.2 Model-based P&T System inputs required.....	18
4.5 Basic Model-based P&T System Operating Procedures	19
4.6 Proposed Model-based P&T System Outputs	20
4.7 Typical Model-based P&T System Test Data	21
4.8 Evaluation of the Model-based P&T System Outputs.....	23
4.8.1 Operational Evaluation of the Mark II P&T System.....	23
4.8.2 Theoretical Model Evaluation	23
4.8.3 External Review of Theoretically Based P&T System	26
5 Revised P&T System	26
5.1 Objectives	26
5.2 Ideal Gas Law-based In-heading Gas Release Rate Concept.....	27
5.3 Theory of Ideal Gas Law-Based P&T System	27
5.3.1 Lost Gas Calculation	27
5.3.2 Gas Desorption Calculation.....	28
5.4 Revised P&T System Hardware	30
5.5 Ideal Gas Law-based P&T System Results.....	31

6	Conclusions	32
7	Recommendations.....	33
8	References	34
	Appendix A	36

List of Tables

Table 2.1: Inputs required for the model-based P&T System	19
Table 4.2: P&T System peripheral inputs	22
Table 5.1: Initial P&T System results	31

List of Figures

Figure 4.1: Mark I P&T System with trolley	18
Figure 4.2: Typical pressure and temperature vs. time curve from the P&T System	21
Figure 4.3: Typical temperature-normalised pressure vs. time curve	22
Figure 4.4: Comparative data on the actual and base model gas contents	25
Figure 5.1: Lost gas calculation	28
Figure 5.2: P&T System software input screen	29
Figure 5.3: P&T System software output screen	30

1 Introduction

In the pursuit of safe mining practices, it is important for the environmental control practitioner to have an idea of the expected rate of methane release from the coal being mined. This information is invaluable in the design of the most economical section ventilation systems for controlling the risk of flammable gas ignitions. However, the release of methane is rarely constant throughout a seam owing to variations in the physical properties of the seam. Sudden and drastic increases in methane release can therefore occur, and could have disastrous effects if not prepared for. There is therefore a need to be able to assess, on an ongoing basis, the amount of methane that is released at the working face during mining.

2 Practical Methods for determining the Coal Seam Gas Content

Some of the earliest work on the determination and prediction of gas release from a coal seam was done by Bertard *et al.* (1970) in the late 1960s. The work describes a “direct method” in which the amount of gas desorbed from a coal sample is measured directly. The method consists of three steps, namely physically measuring the gas desorbed, extrapolating from this the lost gas, and lastly determining the residual gas. The sum of these three components gives an indication of the total gas content of the coal sample, and, by extension, of the seam. Bertard *et al.* sealed drill chippings in a hermetic container, and monitored the gas being liberated from the sample by water displacement over a period of time. By recording the time delay between the drill chippings being cut from the seam and being sealed in the container, and using the initial gas desorption rate, they calculated the potential gas desorbed, i.e. ‘lost’ from the time the chippings were cut from the seam to the time they were sealed in the container. The residual gas in the sample is determined by crushing the sample to expedite the release of the remaining gas.

During the mid-1970s, Kissel *et al.* (1973) developed a direct method for determining the gas content of coal beds by refining the Bertard method. McCulloch and Diamond (1976) further modified the method. They eliminated the need for a laboratory to determine the residual gas

fraction in the sample by estimating this from graphs based on empirical data. This allows estimations of gas content to be made in the field.

In the early 1990s, the direct method was further refined by Ulery and Hyman (1992). It was contended that the direct method, as hitherto applied, had shortcomings that compromised the accuracy of gas content determination. By taking into account the ratio of desorbed gas volume to free space volume in the sealed canister, correcting for temperature and ambient pressure variations, and the composition of the desorbed gas, the accuracy of the direct method was improved.

Other modifications to the direct method have been proposed and developed over the years. In Japan Ohaga *et al.* developed a portable instrument that uses samples of coal from cuttings. The methane content is then determined essentially by the same method as developed in the United States. The residual gas from the samples is not determined, as it is believed that it amounts to less than 10 % of the total gas released. Similarly, a bubble desorbometer (Plaizer and Hucka, 1991) was developed in Germany that can measure the methane content of the coal at the face. This method is also based on measuring the gas desorption from a coal sample.

Although the direct method in all its guises has been fine-tuned over the past 30 years, some fundamental problems still remain unresolved. The first of these is the determination of the lost gas fraction. Several methods for determining this have been proposed (Plaizer and Hucka 1991), e.g. quadratic decaying functions, power decaying functions or exponential power functions. Consensus on which of these to adopt as the standard is still lacking, however. By its very nature, this quantity must be estimated on the basis of a coherent and consistent “best guess” criterion. Unless a process can be developed for actually measuring this quantity, the question of accuracy remains debatable.

The second major problem with the direct method is the duration of a complete test, which gives rise to a long time delay between sample collection and the availability of final results, typically in the order of weeks. To some extent this delay can be reduced by taking smaller samples, but at the expense either of confidence in the representativeness of the data, or of having to increase the number and frequency of samples, since substantial variations can be

found amongst samples taken in close proximity to one another. The time delay can also be addressed by using graphs, based on empirical formulas, to predict the seam gas content, again with accuracy implications (McCulloch and Diamond, 1976; Cook 2001).

Another approach to determining the seam gas content was discussed by Airey in 1968. He developed an empirical equation, based on the results from standard gas desorption tests, similar to that mentioned by Bertard *et al.* (1970), that could be used to determine the rate of gas emission from broken coal in the size range from 12,7 mm to dust. The empirical equation was developed for the deep soft coal found at Sherwood Colliery. In 1987 Banerjee in India developed a similar method for determining the gas content of coal, based on the work done by Airey (1968). He made use of a transformed Airey equation with good results. Since this method is empirically founded, the range of application is uncertain and caution must be exercised when contemplating its use.

From the preceding discussion it is clear that there is a definite need for a method that will yield reliable information in a short period of time, give representative values for gas release rates in a production heading, give total expected seam gas content, and can be operated reliably by mine personnel.

3 Current South African Practice

The current method used in South African collieries to determine the seam gas content is based on the system developed by Kissel *et al.* in the 70s (Cook 1993). The equipment has been refined over the years but the basic principle, with its shortcomings, has stayed the same.

Due to the need for 'quick' results, an empirically based system has been developed for South African conditions. The system, known as the "on-the-spot methane rating system", was developed by Itasca Africa (Cook, 2001). This system is based on the gas content results obtained over the past few years. It measures the gas desorption from a cut coal sample, using the water displacement method, over a few minutes. The volume of gas desorbed is then used to predict the potential emission rate and the gas content of the coal using a

empirically based chart. The system is well suited to performing multiple tests in a section to obtain a reasonable estimate of the potential gas emission rate and gas content of a coal seam.

4 New Theoretical Seam Gas Content Determination

Concept

4.1 Objective

Based on the information available on current systems for determining the seam gas content and emission rate of cut coal, it is clear that there is a need for a new system. For this system to be an advancement on current systems, it needs to:

- increase the accuracy
- reduce the guess work involved
- reduce the time required to obtain results
- simplify the system to enable mine personnel to use it accurately.

In order to achieve these objectives, it is important to eliminate, or significantly increase the accuracy of, the lost gas determination and to automate the system as far as possible in order to reduce human error and intuition.

4.2 Theoretical Seam Gas Content Determination Concept

The liberation rate of gas from cut coal is governed by numerous variables and parameters. It is postulated that for each distinct set of variables and parameters, there is a unique gas liberation curve. If an accurate gas emission model could be found that utilised these variables, typical desorption curves for coal samples could be generated theoretically. These curves could then be used to determine the gas desorption characteristics of the seam theoretically, eliminating the need for separate lost gas and residual gas procedures and hence increasing accuracy.

The CSIR's Division of Mining Technology (Miningtek) developed a comprehensive gas flow model for simulating the liberation and transport of gas in geological structures, including coal horizons (Linzer, 1995, SIMRAC COL 030). A part of this model considers diffusive and sorptive gas phenomena in a carboniferous matrix. On the assumption that gas liberation and transport in freshly cut coal is predominantly diffusive and sorptive in nature, this part of the model can be used as the theoretical basis for interpreting measured gas desorption data from cut coal.

Expanding on the above postulation, it was found that the theoretical gas emission curve obtained from the model depends on five parameters:

- initial (or virgin) seam gas pressure
- the two Langmuir constants
- the diffusion coefficient
- the fracture network size.

By suitably adjusting each of these parameters, virtually any physically possible gas liberation curve can be prepared. In this way, a best-fit regression analysis of the theoretical model on measured gas desorption data can be obtained, giving a fixed set of parameters that best accounts for the observed gas desorption behaviour of the coal sample investigated. By modifying the theoretical model to simulate underground atmospheric conditions, and applying the parameter set identified, the seam gas content and emission rates of the sample can be easily and accurately calculated.

Using the approach outlined above, the lost gas fraction during sample collection is integrated into the model and requires no special procedure for its estimation. Similarly, residual gas amounts are inherent in the model formulations and require no additional processing. All three gas components are subsumed under the same model, and hence the accuracy of the method depends on the accuracy of the theoretical model, the quality and quantity of the measured data, and the quality of the numerical analyses applied to the measured data.

4.3 Theory Behind Desorption Model

As mentioned earlier, the model assumes that diffusive and sorptive flow are the dominant flow mechanisms in cut coal. This assumption is justified when one considers that cut coal consists of small fragments, very few of which are markedly larger than the average spacing of fractures. Therefore, each of these fragments incorporates only a comparatively small portion of the fracture network, which governs Darcy permeable flow, and thus no significant free gas pressure in fracture voids is likely to be found. Consequently, Darcy permeable flow will not have an appreciable effect on the gas liberation behaviour in cut coal. Diffusive gas flow in a coal particle is described by the following equation:

$$\frac{\partial C}{\partial t} = \frac{1}{A} \tilde{N}(D \times A \times \tilde{N}C) \quad (1)$$

where

C	=	mass concentration of the diffusing substance in the medium at location (x, y, z) and time t
t	=	time
A	=	location-dependent cross-sectional area perpendicular to the principal flow direction
D	=	location-, temperature-, concentration-, etc. dependent diffusion coefficient
\tilde{N}	=	scalar <i>del</i> operator ($\tilde{N} \bullet \frac{\mathbf{1}}{\mathbf{x}} + \frac{\mathbf{1}}{\mathbf{y}} + \frac{\mathbf{1}}{\mathbf{z}}$)

The relative complexity of the above equation disallows a useful analytical solution that satisfies the required initial and boundary conditions of the problem. The analytical solution, although exact, contains a sum of an infinite number of terms, and is therefore not particularly useful. For this reason it would be beneficial if the problem were formulated in a generic manner independent of specific values of the variables and parameters it uses, so that a general solution may then be sought. This is achieved by introducing certain assumptions:

- Natural cleats and fractures divide the coal into a regular matrix of small cubes, each of which has a side length of 2λ (λ = half side length).
- Diffusive transport of gas is symmetrical from the geometric centre of the cube with

respect to all the symmetry planes of the cube.

- A cube can be divided into six similar right pyramids, each with its apex at the geometric centre of the cube and its base being one of the cube's faces. In each of these pyramids, gas migration is unidirectional along the pyramid's perpendicular height, so that the problem is simplified to one space dimension.
- The diffusion coefficient is constant throughout the cube.
- Sorptive processes on the outer surfaces of a cube respond instantaneously to changes in gas pressure.

By introducing a Cartesian co-ordinate system such that the apex of one pyramid lies at its origin and the x-axis lies along the principal flow direction, i.e. along the perpendicular height of the pyramid, and applying the aforementioned assumptions, Equation (1) reduces to:

$$\frac{\partial C}{\partial t} = \frac{D}{x^2} \times \frac{\partial^2 C}{\partial x^2} \times \frac{\partial C_0}{\partial t} \quad (2)$$

for one-sixth of the cube, with the symbols as before. The initial and boundary conditions are:

$$\begin{aligned} 0 \leq x \leq l ; t \geq 0 ; C &= C(x, t) \\ C(l, t) &= C_s \text{ for } t \geq 0 \\ C(x, 0) &= C_0 \text{ for } 0 \leq x < l \end{aligned} \quad (3)$$

For the boundary value problem given by Equations (2) and (3), there are four parameters that influence its solution, namely the cube size (l), the initial concentration of the particle (C_0), the instantaneous surface concentration (C_s) and the diffusion coefficient (D). These parameters can be eliminated by normalising Equation (2) with regard to time, cube size and gas concentrations via the following transformations:

$$C^* = \frac{C - C_s}{C_0 - C_s} ; x = lx ; t = \frac{l^2}{D} \times t \quad (4)$$

(where τ is a time-specific constant).

Applying these to the boundary value problem, one obtains:

$$\frac{\partial C^*}{\partial t} = \frac{1}{x^2} \times \frac{\partial}{\partial x} \left(x^2 \frac{\partial C^*}{\partial x} \right) \quad (5)$$

subject to initial and boundary conditions:

$$\begin{aligned} t \geq 0 \quad 0 \leq x \leq 1 \quad C^* &= C^*(x, t) \\ C^*(x, 0) &= 1 \quad \text{for} \quad 0 \leq x < 1 \\ C^*(1, t) &= 0 \quad \text{for} \quad t \geq 0 \end{aligned} \quad (6)$$

The total gas content of the cube can be determined as a function of time. Mathematically, the total mass of gas contained by the particle is given by:

$$Q = 3 \cdot \int_{-1}^{+1} C \cdot r_c \cdot 4 \cdot x^2 \cdot dx = 24 \cdot r_c \cdot l^3 \cdot \left(\frac{C_s}{3} + (C_0 - C_s) \cdot \int_0^1 C^* \cdot x^2 \cdot dx \right) \quad (7)$$

- where
- Q** = total gas content of the particle
 - C** = actual mass concentration of diffusing gas in the coal particle
 - r_c** = density of the coal particle
 - l** = particle half side length
 - C_s** = particle surface gas mass concentration
 - C₀** = initial particle gas mass concentration
 - x** = normalised principal flow direction co-ordinate
 - C*** = normalised gas mass concentration in the coal particle

Equation (7) requires a solution to the (generalised) boundary value problem given by Equations (5) and (6). However, as indicated earlier, there is no useful analytical solution. A numerical solution scheme was applied and used to evaluate the integral term in Equation

(7) for different values of τ . A regression equation was then fitted to the results, and a reversal of the transformations given by Equations (4) yields the final equation, which relates the mass of gas in the particle to the actual time, t :

$$Q = 8r_c I^3 (C_s + (C_0 - C_s)e^T)$$

$$T = a_0 t + a_1 \frac{\alpha}{\beta} (1 + a_2 t)^a - \frac{1}{1 + a_3 t^b} \frac{\bar{C}_0^{\frac{1}{\alpha}}}{\beta} \quad \text{and} \quad t = \frac{D}{I^2} t$$

with	a_0	=	7,26394544	a_1	=	-0,512791213
	a_2	=	37,1683463	a_3	=	117,7355547
	α	=	1,87565324	β	=	1,59297522

In order to apply this equation, the surface concentration (C_s) and the initial concentration (C_0) must be quantified in terms of the surrounding gas pressure. This is done by using the well-known Langmuir isotherm. In its usual form, this equation relates specific adsorbed gas volumes to (absolute) gas pressures, but a manipulation of the Universal Gas Law enables the isotherm to be used to relate gas pressure to gas mass concentration:

$$C = \frac{m}{m_c} = \frac{\alpha p_{STD} M_G}{\beta k R T_{STD}} \frac{\bar{C}_0^{\frac{1}{\alpha}}}{\beta} \frac{k_1 k_2 p}{1 + k_2 p} \quad (9)$$

where

m	=	gas mass
m_c	=	coal particle mass
p_{STD}	=	standard pressure
T_{STD}	=	standard temperature
M_G	=	molecular mass of gas
k_1, k_2	=	Langmuir constants
k	=	gas supercompressibility fraction
p	=	absolute gas pressure

Assuming that the surface sorption rates are sufficiently rapid, this equation can be used to

determine the particle surface concentration in terms of the surrounding gas pressure:

$$C_s = \frac{p_{STD} M_G}{kRT_{STD}} \frac{\bar{c}}{\bar{c}} \frac{k_1 k_2 p}{1 + k_2 p} \quad (10)$$

Similarly, the initial particle concentration can be related to the virgin seam gas pressure (p_4) on the assumption that the coal seam has remained undisturbed sufficiently long for the virgin seam gas pressure to be in equilibrium with the totality of adsorbed gas in the coal particles.

$$C_0 = \frac{p_{STD} M_G}{kRT_{STD}} \frac{\bar{c}}{\bar{c}} \frac{k_1 k_2 p_{\Psi}}{1 + k_2 p_{\Psi}} \quad (11)$$

where p_{Ψ} = virgin seam gas pressure (absolute)

If the virgin seam gas pressure, the two Langmuir constants, the diffusion coefficient and the fracture network size of a coal sample are known, Equations (8), (10) and (11) can be used to calculate a theoretical methane emission rate over time from a sample of cut coal, as well as its theoretical methane content. Alternatively, given at least five data pairs that reflect a sample's gas content at different times, a (non-linear) system of equations can be prepared and solved so as to minimise the aberration between the data sets and the theoretical model.

4.4 Concept Data Acquisition System for Theoretical Model

In order to determine the desorption model parameters for quantifying the methane content and the desorption rate, a practical means needs to be found that will uniquely describe the methane release from a coal sample.

One means of quantitatively measuring the gas liberated from a coal sample is to measure the pressure build-up in a sealed container due to the gas desorbed. As temperature fluctuations in a sealed container will cause pressure fluctuations, the temperature in the canister also needs to be monitored.

A system was developed that monitors and digitally stores the pressure and temperature (P&T) in a hermetically sealed container every 30 seconds over a period of 24 hours.

4.4.1 Physical Parameters of Model-based P&T System

The system incorporates the following major components:

- A rigid 26-litre sample container that can be filled with approximately 12 to 15 kg of freshly cut coal.
- A pressure transducer, thermocouple and pressure-relief valve situated in the threaded lid of the canister.
- A digital data logger that can record the pressure and temperature every 30 seconds for up to 48 hours.
- A 24 V battery pack that can support the system for up to 48 hours.

The P&T System can monitor to a gauge pressure of 40 kPa and a temperature of 50 °C. The pressure and temperature readings are recorded on the digital data logger every 30 seconds over a period of 36 hours.

A relatively large sample is used (about 12 to 15 kg) in order to improve the quality of the pressure measurements and to reduce the effects of natural small-scale fluctuations in the composition and character of the coal which impact on its gas retentive and emissive properties, in other words, a larger sample size is likely to improve the overall representativeness and accuracy of a test.

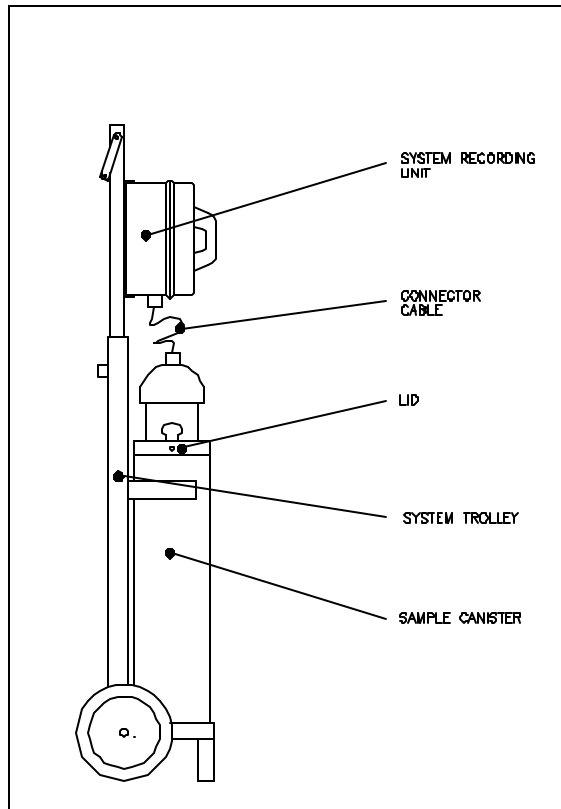

Figure 4.1: Mark I P&T System with trolley

4.4.2 Model-based P&T System inputs required

Apart from sealing the coal sample in the canister and monitoring the pressure and temperature levels, there are other peripheral data that need to be recorded during a test. All the inputs required to determine the seam gas content are listed in Table 2.1

Table 2.1: Inputs required for the model-based P&T System

Model-based P&T System Inputs
Sample mass
Sample volume (optional)
Container volume (fixed, optional)
Time from cutting of sample to sealing
Barometric pressure (optional)
Normalised pressure vs. time data

4.5 Basic Model-based P&T System Operating Procedures

Since the rate of methane liberation during the excavation of coal in a section is to be determined, coal samples won by the usual production method for the section are used. To minimise the effect of methane desorption from the immediate coal face, a sample is taken only after a continuous advance of approximately 6 m into the seam has been made. At this depth, the gas content of the coal would be close to its virgin value, since little desorption would have occurred. Before a sample is taken, the heading is cleared of all “old” cut coal. On starting the sample cut, the time between the cutting of the sample and the sealing thereof in the container is measured. (With the Mark II P&T System, this function is incorporated into the system operation.) At this time, the ambient pressure is recorded (optional).

Once the canister has been sealed, the pressure and temperature inside the canister are monitored for 36 hours. The data logger is downloaded after 31 hours of recording and the pressure data normalised. The sample volume and mass are then determined and recorded. This is done if the density of the coal is unknown.

Once all the inputs required for the system have been obtained, the information is loaded into the system’s software. The software will then calculate the gas content of the sample and the gas release rate.

A full and detailed operating procedure for the Mark II P&T System is given in Appendix A.

4.6 Proposed Model-based P&T System Outputs

Due to the format and quality of data available, the system software can be programmed to calculate various parameters relating to the gas content and release rates of the sample. Examples of typical parameters are the following:

Gas Release Time Constant

This value is a combination of the diffusion coefficient and the fissure network size. It is a comparative measure of the rate at which the coal releases its gas. The larger this number, the faster the coal releases gas. By monitoring this value over a period of time, e.g. weekly, a history of the coal gas release can be obtained. From these data, any increases or decreases in the gas release rate can be speedily identified and the necessary precautions taken.

Total Gas Content

As the term indicates, this value reflects the total amount, in m^3/ton , of desorbable gas trapped in the coal. The volume is standardised to the ambient barometric pressure and temperature conditions in the working section at the time of the test.

Gas Release Rate Index

This index gives an estimate of the average gas release rate over the 30-minute period immediately following the cutting of the coal from the face. The index is expressed in the form of cubic metres of gas released per second, per ton of coal mined. By multiplying this index by the tons mined and the average time that cut coal spends in the section, an indication of the methane released in a section can be gained.

Test Reliability and Correlation of Test

These two parameters are used to check whether the results obtained are within the required accuracy range. If one of these parameters is outside the prescribed values, the test data must be discarded.

The **test reliability** reflects the total number of recorded data points used to determine the

gas release characteristics of the coal. If this value is less than **85 %**, the test data must be discarded.

The **correlation of test** indicates how well the recorded data and the data generated by the program agree with one another. A minimum correlation of **90 %** is required to ensure that the gas release data are reliable.

4.7 Typical Model-based P&T System Test Data

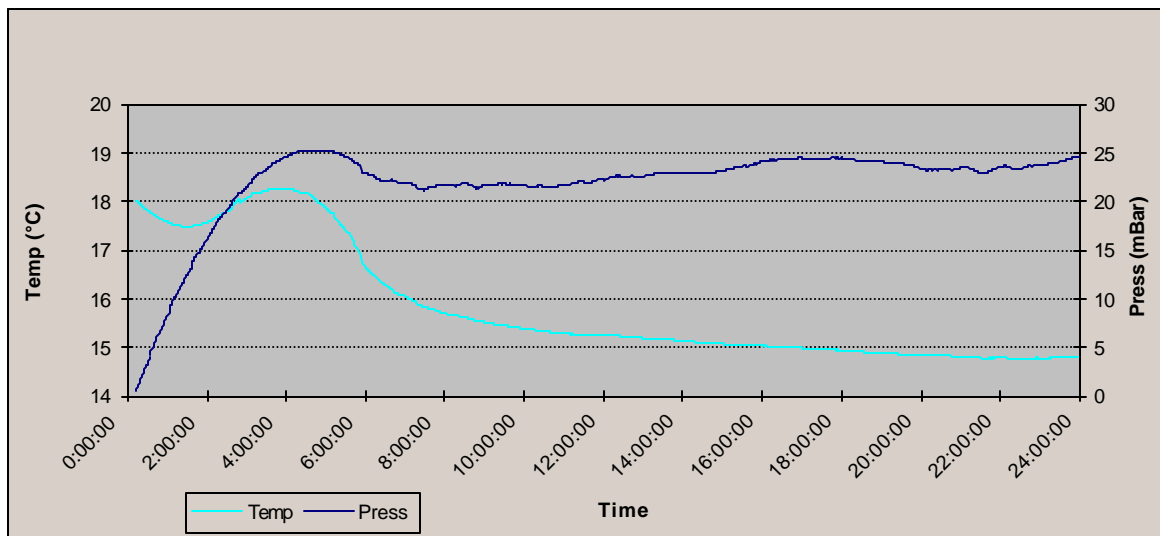

Figure 4.2: Typical pressure and temperature vs. time curve from the P&T System

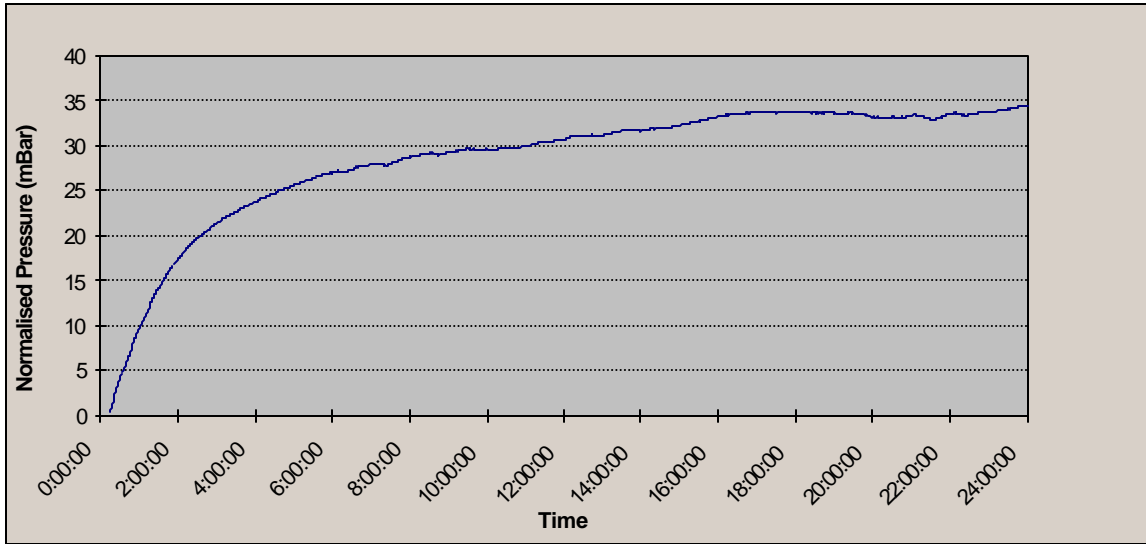

Figure 4.3: Typical temperature-normalised pressure vs. time curve

The pressure curve is normalised with regard to the ambient temperature and pressure when the sample was sealed in the container. This results in a pressure vs. time curve that reflects only the pressure increase in the canister due to the desorption of gas from the coal sample. This can be clearly seen in Figures 4.2 and 4.3.

Table 4.2: P&T System peripheral inputs

Date	13/03/2001
Time	11h02
Mine	X
Section	X
Seam depth	120
Seam mined	c-lower
Ambient Temp (°C)	20.4
Ambient press (mBa)	822

4.8 Evaluation of the Model-based P&T System Outputs

4.8.1 Operational Evaluation of the Mark II P&T System

The initial conclusion is that the prototype is too bulky. The separation of the canister from the logging unit (Figure 4.1) with a connector cable, combined with the bulkiness of the system, made this a very weak link in the system. Several data sets were lost due to the shearing off of the connector cable. Although a special frame was constructed to make the system more robust and manoeuvrable, and to protect the connector cable, data were still lost due to shearing off of the cable.

Problems were also experienced with the modified data logger, in that making it intrinsically safe reduced the reliability of the logger to below 50 %. Problems were experienced with logger failure in that data were lost when power to the logger was interrupted.

Due to its bulkiness, it is also difficult to move the system underground without dedicated cruiser transport.

The combination of these factors makes the acquisition of data sets very difficult and cumbersome.

For the system to be used underground, these shortcomings need to be addressed.

4.8.2 Theoretical Model Evaluation

Using the field data sets, the theoretical 'base model' derived for the P&T System was evaluated.

It is assumed that methane emission from broken coal occurs in a large collection of homogeneous isotropic coal particles of cubic shape.

The dominant flow mechanism within these cubes is diffusion, governed by Fick's Law. Thus,

through the assumed isotropy and homogeneity of the coal, the diffusion coefficient is taken to be a constant throughout a cube over the period that it emits gas. It is also assumed that before it was broken or disturbed, the adsorbed methane was in a state of equilibrium with the coal. Thus, the initial gas concentration in the cubes is assumed to be uniform.

To solve the diffusion problem in a coal cube, the cube was divided into six equal right pyramids, whose bases formed the six sides of the cube and whose apexes met at the geometric centre of the cube. Each of these pyramids was assumed to behave in a similar manner and the flow of gas was assumed to be unidirectional along the perpendicular height, from the apex towards the base, in each pyramid. This reduced the dimension of the problem from four (three x space + time) to two (one x space + time).

The mathematical equation and its initial conditions describing the diffusion process were normalised (non-dimensionalised) by choosing suitable transformations and scalings for the variables in order to completely remove any and all dependences on instance-specific parameters (particle size, diffusion coefficient, initial concentration).

The governing equation quantifies the gas concentration distribution inside the pyramid as a function of time, but this is not of any direct practical value. What is far more important is to be able to describe the total amount of gas retained in the pyramid (and hence the cube) at any given time. In other words, the internal gas concentration profile must be integrated over the volume (or mass) of the pyramid to obtain the total retained amount per pyramid.

A finite difference phrasing of the normalised equation was solved and integrated numerically at several selected points over an interval of "time" (i.e. scaled proper time). This was done with the pyramid divided into a number of slices ranging from 25 to 2 000 in order to compare the results with regard to consistency. The points so obtained were then plotted and a regression curve was fitted to them.

This curve effectively describes the total gas content of a single coal cube for any cube size, diffusion coefficient and initial concentration, and was Base Model I.

The regression curve is highly accurate with respect to the numerically computed values - the

regression coefficient is better than 0,999 999 - but it was found that although qualitatively its shape is very similar to that found in field trials, its curvature at all points cannot be made sufficiently close to the observed data by a simple linear scaling of the governing parameters. This, in turn, significantly diminishes the confidence with which one can apply it as a basis for analysing other observed data.

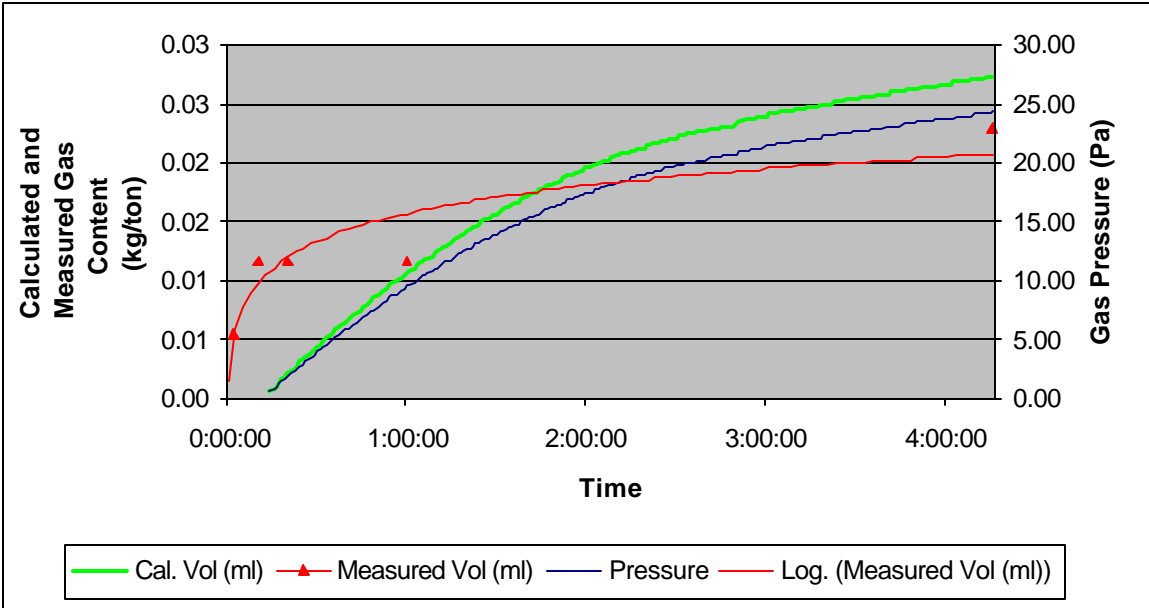

Figure 4.4: Comparative data on the actual and base model gas contents

To address the above deficiency, the assumption of a uniform particle size was dropped, since it was felt that this was the model's weakest link. Further analysis proceeded from the assumption that the coal particle sizes followed a Rosin-Rammler profile. Applying this to the existing model, and reworking the regression fit accordingly, resulted in Base Model II.

The problems of Base Model I were alleviated in this way, but only slightly so. Indications from other field tests are that there is an effect (probably chemical in nature – readsorption or conversion of the gas in certain regimes) that must be incorporated into the base model to fully account for the observed gas emission profiles.

At this stage it was decided to have the base model evaluated by independent external experts in the field.

4.8.3 External Review of Theoretically Based P&T System

The following conclusions/questions were drawn/raised by the external experts (Napier, 2001):

- Is diffusion the correct physical description for gas release? Has the possibility of a point gas release source been considered?
- The overall model appears to be essentially empirical and not fundamental.
- The base model appears to have unnecessary and unmotivated components, e.g.
 - The use of random variables is not substantiated by observations.
 - The use of corrections for 'turbulent flow' in ducts seems an elaborate approximation.
- Isn't a simpler model possible?
- Are the Langmuir constants the appropriate form of isotherm physics?

Based on the above comments, it was concluded that much effort would be required to develop a base model that would be able to uniquely described the desorption parameters as required by the model. Even if such a model could be realised, it would take a considerable amount of time and effort to achieve this, with uncertain results.

The decision was then taken to develop a model that would utilise the hardware already developed.

5 Revised P&T System

5.1 Objectives

The objectives of the revised P&T system were to:

- accurately determine in-heading gas release rates
- easily determine in-heading gas release rates
- make information available in as short a time as possible.

These objectives were to be met by using the hardware developed for the model-based P&T System.

5.2 Ideal Gas Law-based In-heading Gas Release Rate Concept

If it is assumed that the increase in pressure that takes place during the first 30 minutes that a coal sample is sealed in a canister has a minimal effect on the gas desorption rate from the coal, then the pressure increase can be used to determine the volume of gas released from the sample. The Ideal Gas Law can be used to 'convert' the recorded pressure data for the first 30 minutes to the volume of free gas at ambient pressure conditions. Due to the amount of data recorded, the first ten minutes of data recorded can be used to accurately calculate the amount of gas the sample has lost by applying standard regression techniques. As the information is digitally stored, it easily can be used in conjunction with a PC or similar processor to automatically calculate the in-heading gas release rate of the sample, and other indices if required.

5.3 Theory of Ideal Gas Law-Based P&T System

5.3.1 Lost Gas Calculation

The pressure data for the first 10 minutes after the sample has been sealed in the container are used to calculate the lost gas. This is done by applying a second-order polynomial regression equation to the data. From the regression equation, the volume of lost gas can be calculated by using the time required from when the sample is cut from the seam to when it is sealed in the canister. The Mark II P&T System software does this automatically.

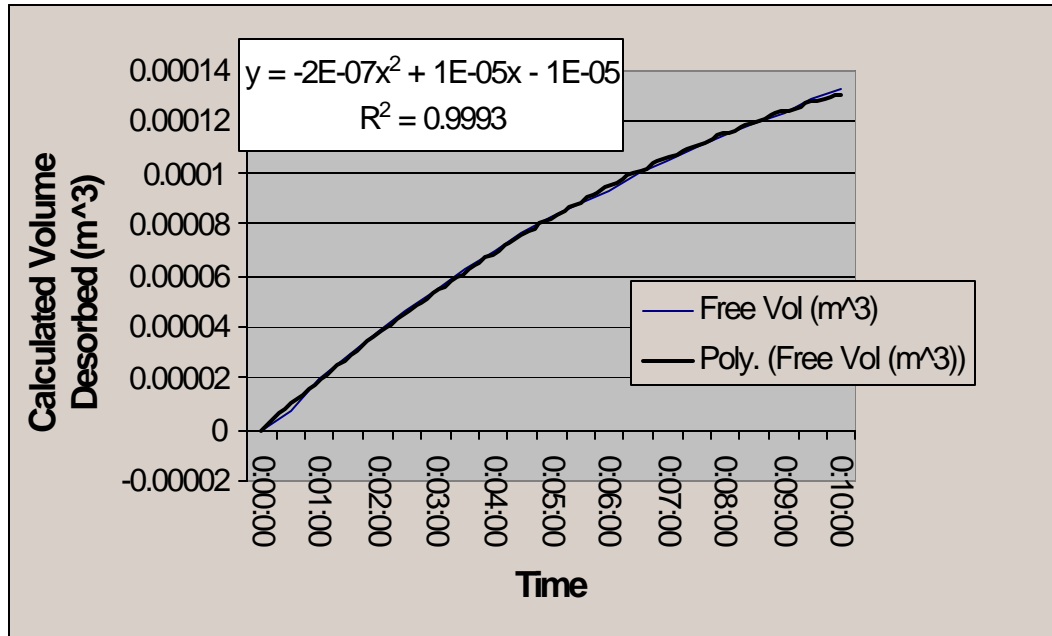

Figure 5.1: Lost gas calculation

5.3.2 Gas Desorption Calculation

The Ideal Gas Law states:

$$PV = nRT \tag{12}$$

- with P = pressure (Pa)
- V = volume (m³)
- n = mole
- R = universal gas constant (m³.Pa/mol.°K)
- T = temperature (°K)

From this, the following equation can be derived:

$$\frac{P_1 V_1}{T_1} = \frac{P_2 V_2}{T_2} \quad (13)$$

Using this equation, the pressure build-up in the sealed canister can be converted to the volume of gas released at atmospheric pressure from the coal sample. This calculation can be done for every time interval recorded, resulting in a graph of gas volume desorbed vs. time. By adding the lost gas component to the calculated volume released, the volume of gas released at any point, 30 minutes from the coal having been cut from the face, can be determined. All this is done automatically by the P&T System software. The current software input screen and output screen are shown in Figures 5.2 and 5.3

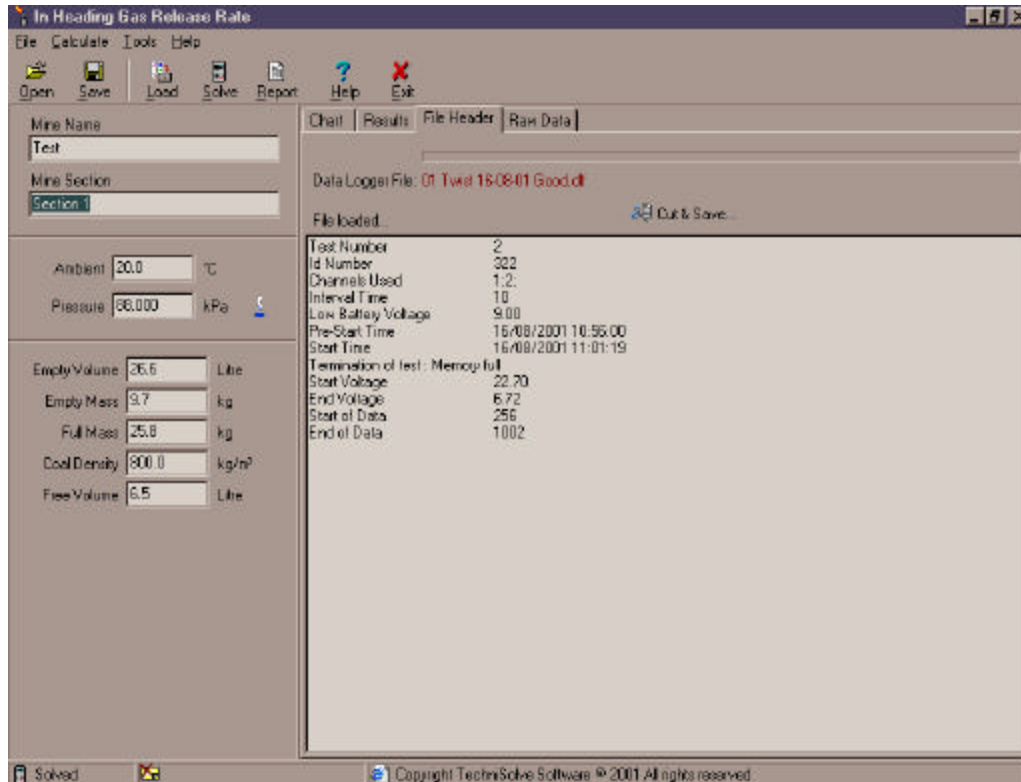

Figure 5.2: P&T System software input screen

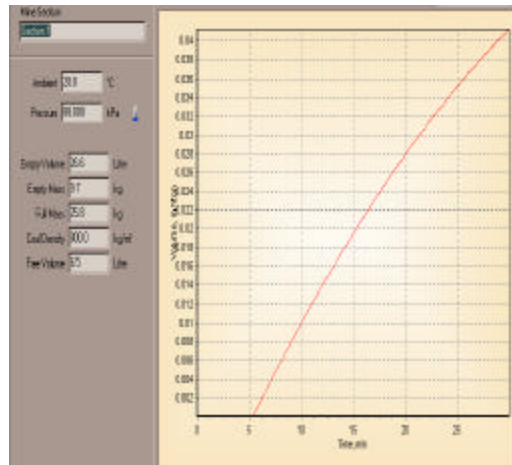

Figure 5.3: P&T System software output screen

5.4 Revised P&T System Hardware

To overcome the deficiencies of the original Mark II P&T System, a new system was developed. This system incorporated the following new features, which made it more suitable for general underground use:

- Smaller and more manageable size
- Integrated data logger and container unit
- Dedicated data logger system with software
- Micro-switch to activate logger on closing of the lid
- Self-diagnostic abilities for increased accuracy
- Underground reset facilities
- Indicators to determine test status
- Dedicated Windows-based software.

The system was developed to ensure easy and accurate use underground. The self-diagnostic features of the unit also allow the quality and integrity of the data to be ensured. Full system details and operational procedures are contained in Appendix A.

5.5 Ideal Gas Law-based P&T System Results

Several tests have been completed with the new P&T System. The standard direct test method, as currently used in South Africa, was used to verify the accuracy of the initial test results from the P&T system. These results are given in Table 5.1.

Table 5.1: Initial P&T System results

No.	Mine	P&T System Results* (m³/ton)	Direct Test Method (m³/ton)
1	Mine A	0,13	0,10
2	Mine A	0,09	0,07
3	Mine B	0,00	0,01
4	Mine B	0,00	Not detected
5	Mine B	0,00	Not detected
6	Mine C	0,00	Not detected
7	Mine C	0,00	Not detected

*Results reflect the gas desorbed in the first 30 minutes after the sample has been being cut from the seam.

From the table it can be seen that the P&T System results compare favourably with the data obtained from the standard direct test. For four of the mines, which have a history of low seam gas content, it can also be said that the P&T System confirmed this trend. Actually, the pressure curve obtained for these tests shows a negative pressure gradient. This is most likely due to oxidation of the sample in the canister, as no or very little gas is desorbed from the coal sample.

From the limited results, it would appear that the P&T System overestimates the gas released in the heading. This is probably due to the increased accuracy in determining the lost gas component.

6 Conclusions

- The theoretical simulation of gas desorption from broken coal is a very complex matter which is difficult to solve in a practical way. The gas desorption model that was originally developed is unable, in its current form, to simulate the gas release from broken coal accurately enough. If such a model can be developed successfully, the proposed P&T System will be well suited to provide field data for inputs.
- The concept of using a gas desorption model based on data on pressure build-up due to the desorption of gas from coal in a container to determine in-seam gas content is sound.
- It is foreseen that extensive resources and time would be required to solve the model adequately for it to be used commercially. Moreover, such an outcome is not guaranteed.
- By using the Ideal Gas Law, the data on pressure build-up in a hermetically sealed canister can be used to accurately predict the rate of gas release for the first 30 minutes of cut coal from the face.
- By using a regression equation, with regression coefficients of $> 0,99$ achieved, the lost gas from the coal sample can be easily and accurately determined.
- Due to the nature of the operation of the P&T System, it can be used to easily and accurately determine the gas release rate from and gas content of broken coal in a heading for the first 30 minutes after it has been cut from the seam.
- The semi-automated operation of the P&T System confers good data integrity evaluation, and hence reliable results.
- The system allows gas release rate monitoring to be done easily in house.
- The digital format allows effective record-keeping.
- The quantity and quality of the data allow release rate indicators to be developed for predicting potentially hazardous conditions.
- The P&T System needs to be made more ergonomically suitable for general underground use.
- If possible, the system needs to be able to give *in situ* results.
- The information generated by the P&T System can be incorporated into currently available gas content prediction tools, e.g. the “on-the-spot” methane rating system.

7 Recommendations

- Develop an ergonomically suitable P&T System.
- Confirm the accuracy of the system against standard methods.
- Endeavour to enable the system to give results *in situ*.
- Develop a database to predict trends in gas release rates in production and development headings.

8 References

Airey, E.M., 1968. Gas emission from broken coal: An experimental and theoretical investigation.

Banerjee, B.D., 1987. A new approach to the determination of methane content of coal seams.

Banerjee, B.D., et al., 1987. Investigation on methane emission in Indian coal mines.

Bertard, et al.

Cook, A.P., 1993. Determining the methane content of a coal seam by means of the direct method: A review of the procedures.

Cook, A.P., 2001. Methane rating on-the-spot: Technology transfer of methane rating. Technical Note, Itasca Africa (Pty) Ltd.

Creedy, D.P., 1985. Methods for the evaluation of seam gas content from measurements on coal samples.

Diamond, W.P. and Levine, J.R., 1981. Direct method determination of the gas content of coal: Procedures and results.

Kissel, F.N., McCulloch C.M. and Elder C.H. 1973. The direct method of determining methane content of coal beds for ventilation design. USBM Report of Investigation RI7767.

Linzer, P., 1995. A numerical simulator for 3-D unsteady state dual porosity modelling of gas flow within a coal structure. Proc. 7th US Mine Ventilation Symposium.

McCulloch, C.M. and Diamond, W.P., 1976. Inexpensive method helps predict methane

content of coal beds.

Napier, J. (CSIR Miningtek), 2001. Personal communications.

Ohga, K., et al., A new technique of determining the methane content in-situ.

Plaizer, R.R. and Hucka, V.J., 1991. In situ determination of desorbable methane content by use of three decay functions.

Smith, D.M. and Williams, F.L., 1981. A new technique for determining the methane content of coal.

Smith, D.M. and Williams, F.L., 1983. Diffusion models for gas production from coals: Application to methane content determination.

Smith, D.M. and Williams, F.L., 1983. Direct method of determining the methane content of coal: A modification.

Ulery, J.P. and Hyman, D.M., 1992. The modified direct method of gas content determination: Applications and results.

Appendix A



OPERATIONAL PROCEDURE FOR IN- HEADING GAS RELEASE RATE DETERMINATION

- P&T System -

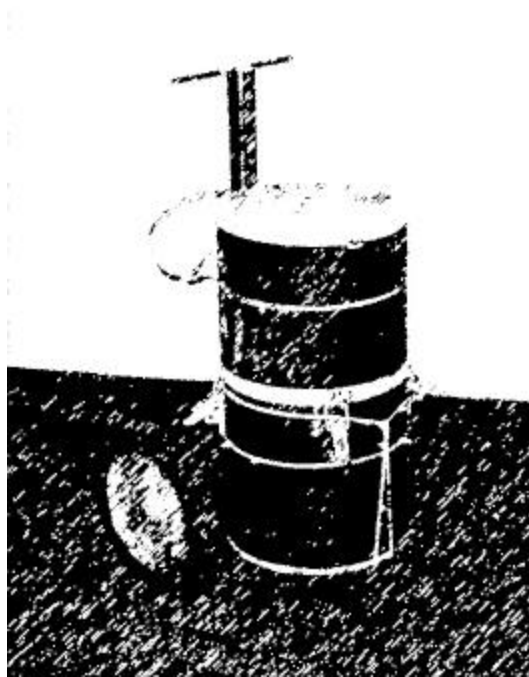

CSIR MININGTEK

2001

FOREWORD

The P&T system was developed to enable an underground colliery to quickly and accurately determine its in-heading gas release rate. The system is easy to operate and can yield data within 30 minutes.

The methane gas release rate is calculated by monitoring the pressure (P) build-up, due to gas desorption from a coal sample, in a rigid airtight container. As temperature (T) variations will affect the internal pressure of the system during a test, the temperature in the container is also monitored. The temperature values are then used to adjust the

pressure readings so that the pressure curve will only reflect a pressure increase due gas release from the coal. The resulting pressure vs. time curve is then used to calculate the volume of gas desorbed from the coal sample during the first 30 minutes of being cut from the coal seam.

The ideal gas law is used to calculate the volume of gas released. The results are given in m^3/ton for the first 30 minutes of gas desorption. This information can be used to assess the potential gas release rate into an operational section from the coal cutting process.

The system was developed in such a manner so that it is easy to operate with minimal inputs required from the operator. The operational procedures for the system are discussed in the following sections. The operational procedure is broken up into four major operations, i.e.

- i. Pre-test procedure
- ii. Underground procedure
- iii. Post-test procedure
- iv. Seam gas release rate determination.

TABLE OF CONTENTS

1. Pre-Test Procedure.....	41
1.1 Hardware Preparation.....	41
2. Underground Test Procedure.....	41
2.1 Equipment Required.....	41
2.2 Site Information.....	42
2.2.1 Complete the test data sheet as shown in Appendix C.....	42
2.3 Logger Preparation.....	42
2.4 Sample Acquisition.....	42
2.5 Logger Operation.....	42
3. Post-Test Procedure.....	43
3.1 Logger Connecting.....	43
3.2 Logger Data Download.....	43
4. In-Heading Gas Release Rate Determination.....	44
4.1 Inputs Required.....	44
4.2 Gas Release Software Operation.....	45
5. In Heading Gas Release Rate Output Data.....	47

APPENDICES

APPENDIX A - PRESSURE TRANSDUCER CALIBRATING PROCEDURE

APPENDIX B - SYSTEM BATTERY CHARGING PROCEDURE

APPENDIX C - TEST DATA SHEET

APPENDIX D – EXAMPLE GAS RELEASE RATE REPORT

The P&T In-Heading Gas Release Rate System



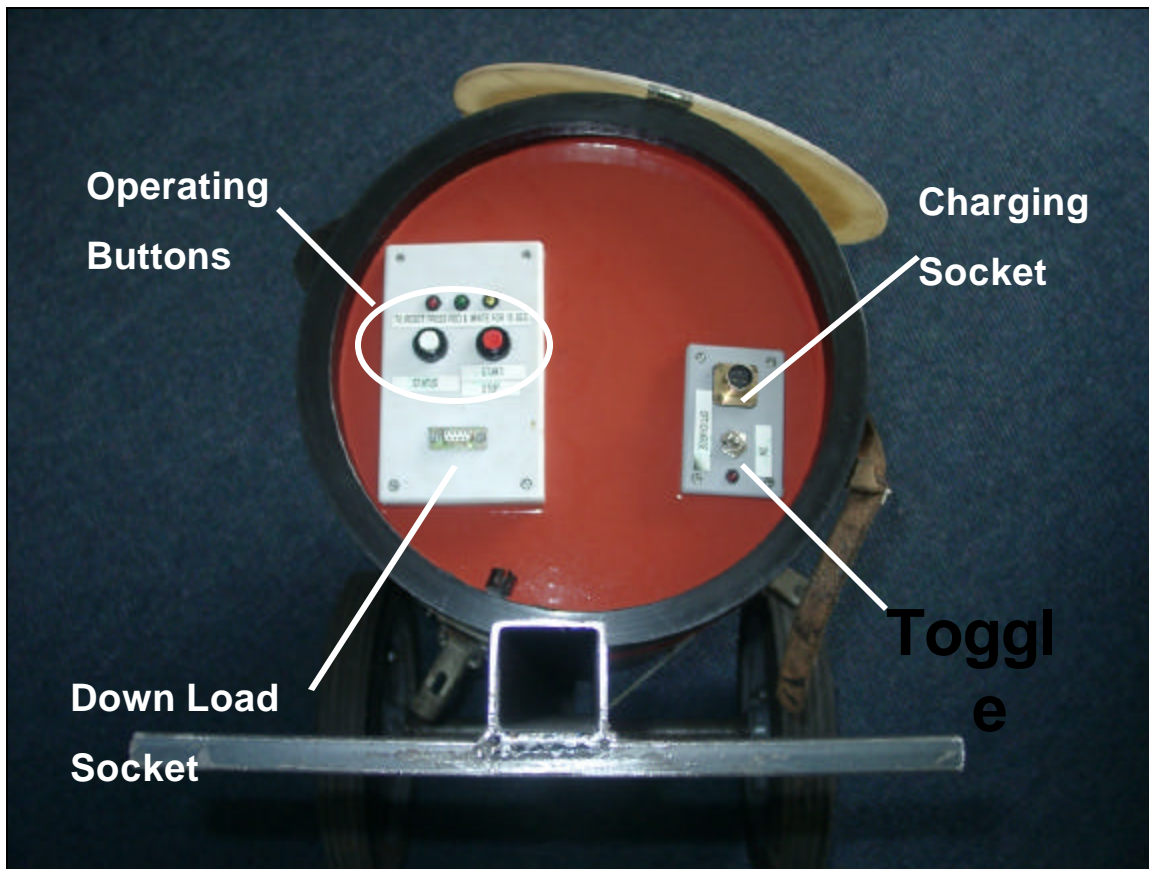

P&T Control Panel

Pre-Test Procedure

Hardware Preparation

- 1.1.1 Check that the pressure transducer is still within its calibration period (see Appendix A).
- 1.1.2 Ensure that the system battery is fully charged (Appendix B).
- 1.1.3 Weigh the empty P&T System. Record the mass of the container on the test data sheet (Appendix C).

Underground Test Procedure

Equipment Required

- 2.1.1 An operational P&T System (Section 1.1).
- 2.1.2 Shovel for sample taking (optional).
- 2.1.3 Test data sheet.
- 2.1.4 Dry bulb thermometer (optional).
- 2.1.5 Barometer (optional).

Site Information

Complete the test data sheet as shown in Appendix C.

Logger Preparation

- 2.3.1 Remove the 'lid' from the sample container and place it in safe clean place near the sample collection point.
- 2.3.2 Ensure that the battery-charging switch is in the "ON" position.
- 2.3.3 Reset the system data logger by holding down the red and white buttons simultaneously for 10 seconds. All three LED's will flash indicating that the logger has been set. If the status button is pressed (white) all three LED's will light up, indicating that the system is ready for use.

Sample Acquisition

- 2.4.1 It must be remembered that freshly cut coal from a mechanical miner is used in the test.
- 2.4.2 The mechanical miner must have advanced without interruption for approximately 6 meters (approximately 8 to 10 shear cycles) in a straight prior to sample taking.
- 2.4.3 The gathering-arm loading area in front of the mechanical miner must be cleared of cut coal once the 6-meter advance has been achieved.
- 2.4.4 A sump and shear must then be performed and the coal dumped behind the mechanical miner (or in a shuttle car) (see paragraph 2.5.1).
- 2.4.5 A sample from this coal is then taken. The sample container is filled approximately 66 % with coal. The 'lid' is then placed on the sample container. The sample should contain as little duff as possible.

Logger Operation

- 2.5.1 When the sample sump starts, press the start/stop button (red button) down until

the orange LED flash to activate the data logger. This will start the internal clock to time the 'lost time', which is required to calculate the gas release rate. When the status button (white button) is pressed the green LED will flash, indicating that the system is in pre-test timing mode.

- 2.5.2 After the sample has been taken the 'lid' is placed on the filled sample container and latched down. This will activate the micro switch, indicating sample sealing. When the status button (white) is pressed the orange LED will flash, indicating that the unit is recording.
- 2.5.3 The unit is then left to record pressure and temperature for 1 hour in a safe place.
- 2.5.4 To check if the system is still operational the red button can be pressed. A orange flashing LED will indicate that the unit is still operational. A red flashing LED indicates that an error has occurred and that the test has been abandoned. In this case the logger needs to be reset (§ 2.3.3) and the test procedure repeated. This can be done *in situ*.

Post-Test Procedure

Logger Connecting

- 3.1.1 After the underground test data has been gathered, the system is taken to the location where the data is going to be downloaded.
- 3.1.2 The top lid of the system is then opened, the toggle switched set to 'FUNCTIONING', and the 9-pin cable connected to the computer used to download the data.

Logger Data Download

- 3.2.1 Run the P&T Logger Download software by double clicking on the 'P&T Down Load' icon on the PC.

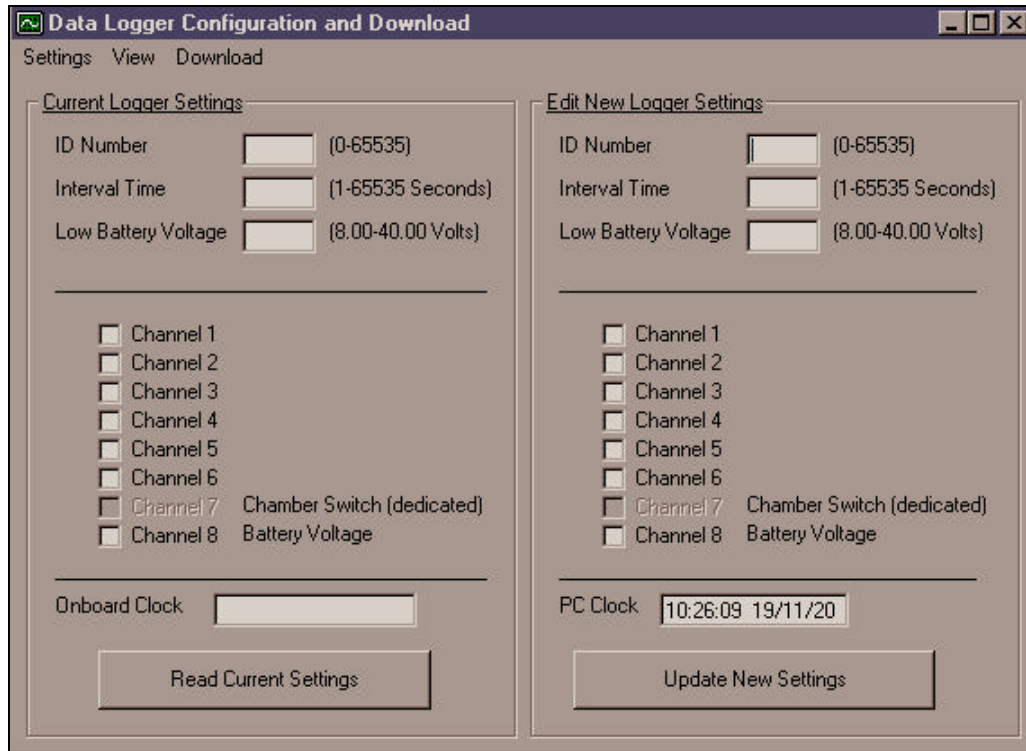

Logger Down Load Software

- 3.2.2 Up load the current data logger settings from the data logger by clicking on the 'Read Current Settings' button. This will populate the 'Current Logger Settings' column.
- 3.2.3 Once this has been done, click on the 'Download logger' from the 'Download' menu bar. This will generate a *.dlf file in a directory of the users choice. It is recommended that the file name chosen has reference to section tested and the date of the test, e.g. S13-050701.dlf = Section 13 on the 5th of July 2001.
- 3.2.4 After the logger has been downloaded, the memory needs to be cleared. This can be done using the 'Clear Logger' option form 'Download' menu bar, or manually on the P&T system itself (see paragraph 2.3.3).

In-Heading Gas Release Rate Determination

Inputs Required

- 4.1.1 Pressure and temperature data file (Section 3).

- 4.1.2 Site ambient temperature (°C)
- 4.1.3 Site barometric pressure (kPa)
- 4.1.4 Coal sample mass (kg)
- 4.1.5 Total container volume (l) (Optional)
- 4.1.6 Container free volume with coal sample inside (l) (Optional)
- 4.1.7 Coal density (kg/m³)

All the data is available on the test data sheet (Appendix C).

Gas Release Software Operation

- 4.2.1 Activate the Gas Release software by double clicking on the Gas Release icon on the screen.
- 4.2.2 Fill in the required fields on the input screen, i.e.
 - Mine name
 - Mine Section
 - Ambient Temperature (°C)
 - Ambient Pressure (kPa)
 - Empty Volume (l)
 - Empty Mass (kg)
 - Full Mass (kg)
 - Coal density (kg/m³)
 - Free Volume (l)

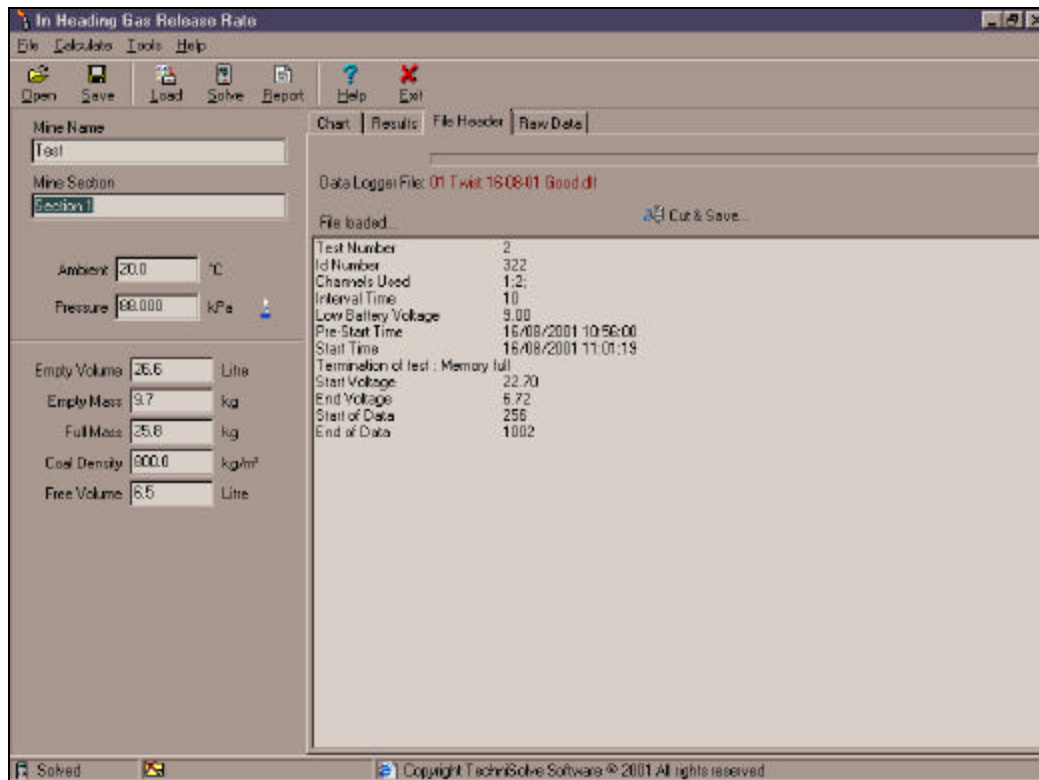

Gas Release Software Input Screen

- 4.2.1 Load the data file for the section to be evaluated. This is done by browsing for the *.dlf file created by the data-logger.
- 4.2.2 Once the fields has been filled in correctly (user will be prompted if out of range values are filled in) and the correct *.dlf has been selected, the in heading gas release rate is determined by selecting the solve button.
- 4.2.3 Once the solver has solved successfully, the data file can be saved and the test report printed.
- 4.2.4 The software has full help facilities to guide the user through the gas release determination process.

In Heading Gas Release Rate Output Data

In heading gas release rate (m³/ton)

This quantity can be read of the table in the report sheet or directly from the output graph.

This quantity refers to the total amount of gas released from the coal sample being cut from the seam to the time in question. This information can be used in conjunction with the production rate (e.g. ton/hour) to determine how much gas is released into the section due to the mining of coal (e.g. m³/hour).

Gas release Rate Graph

This graph shows the amount of gas released from the coal sample against time. This graph should have a smooth positive gradient for the duration of the test. The graph can be used to directly read the amount of gas desorbed per ton at any time of the test.

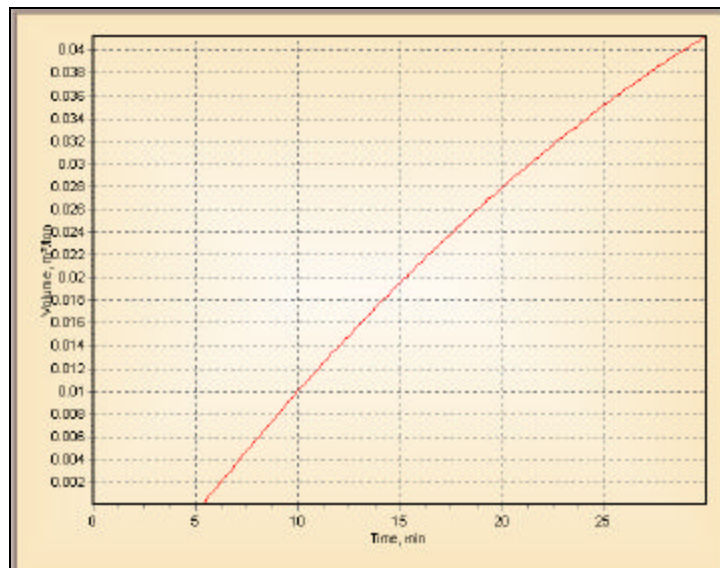

Typical Gas Release Rate Graph

If the graph has a negative curve or any anomalies, the data should be regarded as potentially corrupt. A negative gradient can indicate to leakage, or most likely to oxidation in the sample. This happens in samples with a very low gas content. If this

happens it is recommended that the system be checked and that the test be repeated to confirm the data.

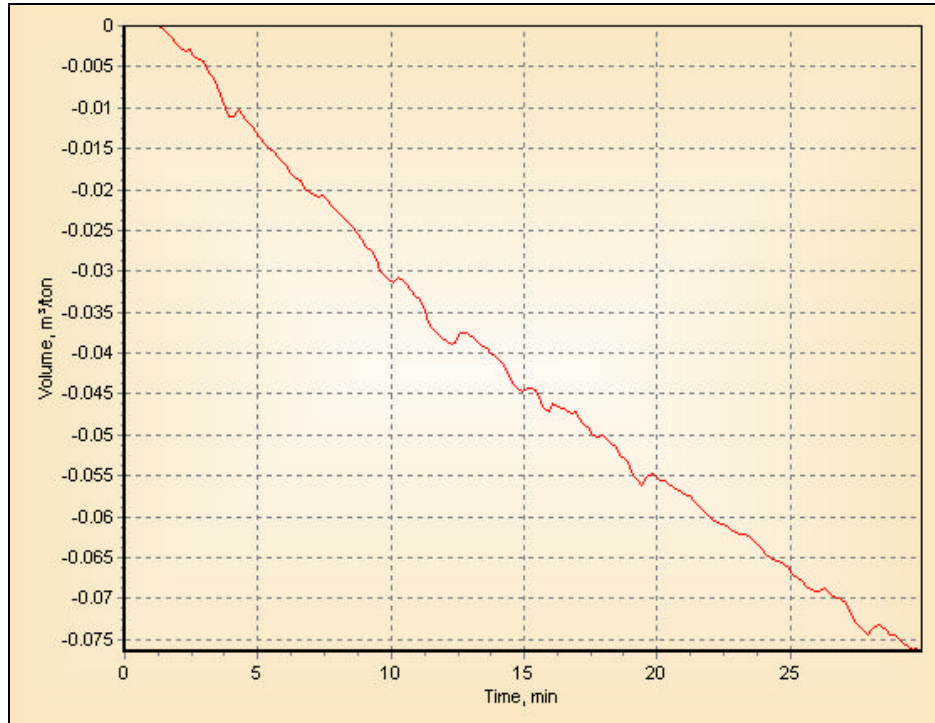

Potentially Corrupt Gas Release Rate Graph

APPENDIX A - PRESSURE TRANSDUCER CALIBRATING PROCEDURE

1. A certified laboratory must calibrate the pressure transducer.
2. The unit needs to be calibrated annually.
3. Ensure that the pressure transducer is within its calibration period.

APPENDIX B - SYSTEM BATTERY CHARGING PROCEDURE

1. Connect the system battery to the battery charger by locking the charger lead into the battery terminal located on top of the system.
2. Flick the toggle switch to the "OFF/CHARGE" mode.
3. Switch on the power to the charger.
4. The red light on the charge panel will light up.
5. The red and green lights on the charger will also illuminate.
6. When the green light switches off, the system battery is fully charged.
7. Remove the charger connector from the battery.
8. Return the toggle switch to the "ON" position.
9. The system battery is now ready for use.

APPENDIX C - TEST DATA SHEET

TEST DATA SHEET - P&T SYSTEM DETERMINATION OF IN-HEADING GAS RELEASE RATE
--

TEST NO. :

CONTAINER NO. : _____

SITE INFORMATION

MINE		DATE (yy:mm:dd)	
SECTION		TIME (hh:mm:ss)	
SEAM DEPTH		AMBIENT TEMPERATURE (°C)	
SEAM MINED		AMBIENT PRESS. (mBar)	
AVG. MINING RATE (tons/shift)		COAL DENSITY (kg/m ³)	

SAMPLE & CONTAINER INFORMATION

1. PRE-TEST INFORMATION	
1.1 EMPTY CONTAINER MASS (kg) (With lid in place)	
1.2 EMPTY CONTAINER VOLUME (l)	
2. POST-TEST INFORMATION	
2.1 FULL CONTAINER MASS (kg) (With lid in place)	
2.2 CONTAINER FREE VOLUME (l) (With coal inside) (Optional)	
3. SAMPLE INFORMATION	
3.1 SAMPLE MASS (kg) (§2.1 - §1.1)	

